

ClearSpan™ Door Frame Kit

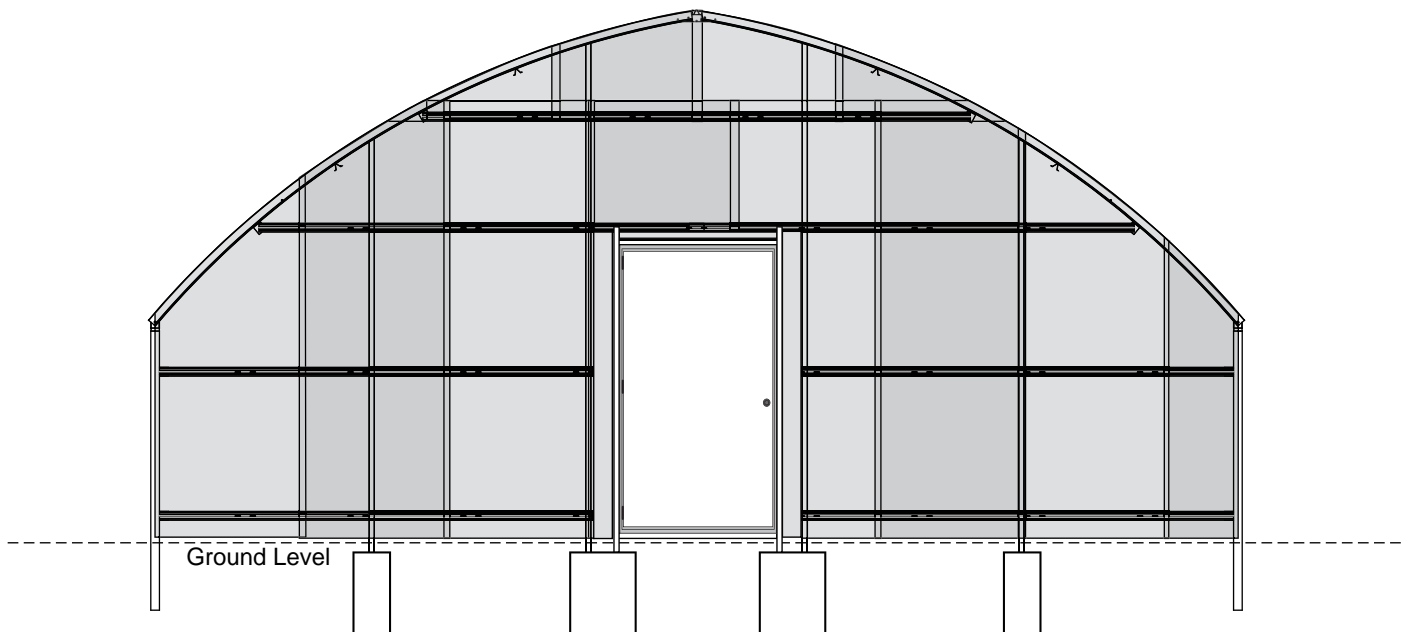

Diagram shows the entry door centered and installed in an end wall frame. The door frame kit includes materials for the door jambs and header only. All other components, including the door, shown above and in other diagrams throughout this guide are not included and require additional purchase.

Table of Contents

| | |
|------------------------------------|----|
| Important Information | 3 |
| Door Frame Assembly | 5 |
| Entry Door Installation | 8 |
| Shelter Care and Maintenance | 9 |
| Quick Start Guide | 10 |
| Door Frame Layout | 11 |

DOOR FRAME KIT: READ THIS BEFORE YOU BEGIN

The door frame kit is designed to attach to the end wall framing kit (R035A00001). These instructions and the instructions for the R035A00001 end wall are written to be used together.

If you have not installed the R035A00001 end frame, consult these instructions as you assemble the framing for both the door and the end wall. Adjust dimensions as needed to accommodate the door installation and location.

NOTE: The R035A00001 end frame is designed to frame an end of one of our roll-form buildings (30' and 35'). Some end frame components may not be used if a door is installed in the end wall.

If you have already installed the R035A00001 end frame, use these instructions to determine the best location for the door and remove the end framing as needed to install this door frame kit. Reinstall end frame as described in this guide.

If you are installing this door frame kit in an end wall that is not the R035A00001 end wall, use these instructions for critical dimensions and details.

Consult the services of a qualified contractor if needed. *It is the responsibility of the owner/contractor to adapt these instructions to safely and competently install this kit in an end wall or building that it was not designed for.*

Complete these steps to install the door frame:

1. Based on the dimensions of the door, determine where you can position the door in the end frame. Use the diagrams from both this manual and the end wall assembly guide.
2. Return to the end wall instructions and frame the end wall as needed based on the door location. Secure the door framing to the end wall framing.
3. Attach the pre-hung door to the door frame. Be sure to determine how you want the end wall panels to attach to the door frame and set the door accordingly.

NOTE: If you purchased a fabric end panel to cover the end wall, install the panel *before* you install the door; then remove the panel material as needed to allow for the installation of the door.

If you purchased a polycarbonate package (8mm twin-wall or corrugated), install those panels after installing the door(s). Panels or parts of panels will remain from the end panel kit resulting from the installation of the door(s).

Important Information



YOU MUST READ THIS DOCUMENT BEFORE YOU BEGIN TO ASSEMBLE THE DOOR FRAME KIT.

Thank you for purchasing this ClearSpan™ door frame kit. When properly assembled and maintained, this product will provide years of reliable service. These instructions include helpful hints and important information needed to safely assemble the door frame kit. Please read these instructions **before** you begin.

SAFETY PRECAUTIONS

- Wear eye protection.
- Wear head protection.
- Use a portable GFCI (Ground Fault Circuit Interrupter) when working with power tools and cords.
- Do not climb on the framing during or after construction.
- Provide proper ingress and egress to prevent entrapment.

⚠ WARNING: The individuals assembling this door frame kit are responsible for designing and furnishing all temporary bracing, shoring and support needed during the assembly process.

For safety reasons, those who are not familiar with recognized construction methods and techniques must seek the help of a qualified contractor.

REQUIRED TOOLS

The following list identifies the main tools needed to assemble the door frame kit. *Additional tools and supports may be needed depending on the structure, location, and application.*

- Tape measure or measuring device
- Fine point marker to mark the location frame members.
- Variable speed drill and impact driver (cordless with extra batteries works best)
- Tool to cut the polycarbonate panel
- Hammers, gloves, and eye protection
- Ladders, work platforms, and other machinery for lifting designed to work safely at the height of the door and door frame.

ATTENTION: Consult the services of a qualified, professional contractor if you are not familiar with the construction of similar frame structures and components.

Important Information

ASSEMBLY PROCEDURE

Following the instructions as presented helps ensure the proper installation of the end frame and door frame. The steps outlining the assembly process are as follows:

1. Verify that all parts are included in the shipment. Notify Customer Service for questions or concerns.
2. Read these instructions and all additional documentation included with the shipment **before** you begin.
3. Gather the tools, bracing, ladders (and lifts), and assistants needed to install the door and door frame.
4. Read the care and maintenance information at the end of these instructions.
5. Complete and return all warranty information as instructed.

UNPACK AND IDENTIFY PARTS

The following steps will ensure that you have all the necessary parts *before* you begin.

1. Unpack the contents of the shipment and place where you can easily inventory the parts. Refer to the Bill of Materials/Spec Sheets.
2. Verify that all parts listed on the Bill of Materials/Spec Sheets are present. If anything is missing or you have questions, consult the parts guide and all diagrams for clarification, or contact customer service.

NOTE: At this time, you do not need to open the plastic bags containing smaller parts such as fasteners and clamps (if equipped).

QUICK START DIAGRAMS

For a quick overview of the end wall, door, and components, consult the diagrams located at the back of these instructions.

PARTS IDENTIFICATION

The following graphics and photos will help identify the different hardware sent with the door frame kit. (Some parts are not shown.)

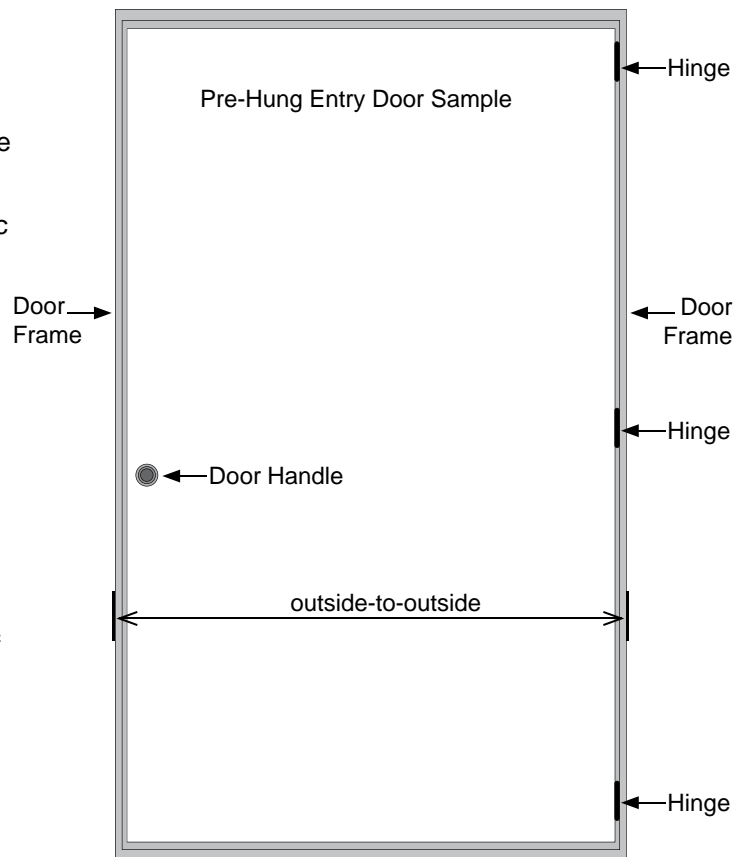

NOTE: When installing the entry door, always use the door frame outside-to-outside measurements. The door is not included with the R035A00014A door frame kit. Additional purchase is required.

Consult the shipping information for an itemized list of components sent with the R035A00014A kit.

Door Frame Assembly

ASSEMBLING THE DOOR FRAME COMPONENTS

Consult the diagrams at the back of these instructions *before* you begin. Assistance is required to assemble the door frame.

INSTALL THE DOOR JAMBS

The following steps describe one way to set the door jambs.

- Using the *outside-to-outside* measurements from the pre-hung framed door, locate and mark the positions of the door jambs. *Be sure to account for the installation of dimension lumber if used to frame and finish the opening.*
- Dig a 10"-12" diameter hole at the locations found in previous step to a depth that is *below the geographic frost line*. (Minimum depth: 24".)
- Locate two (2) 120" door jambs (105488120). Using a metal saw, cut and remove the 2-1/2" sections from one end of each door jamb as shown in photo A. *This creates a lip and allows the jamb to be attached to the girt (see photo B and C).*

ATTENTION: Diagrams A-D show the left door jamb only. *Adjust cuts when cutting the end for the right jamb.*

- Using the diagrams as a guide, attach each jamb to the girts using 108553 wafer head screws as shown in photo C, D, and E.

ATTENTION: Position the door jambs so the open sides of the C-channel face away from the door opening (photo C) and the lip overlaps the girt. When attached to the girt, the lower end of each jamb extends into a ground anchor hole and is secured using concrete. *Consult a knowledgeable contractor if needed.* When installing the lower girts of the end wall, verify that the dimensions for the door frame remains consistent.

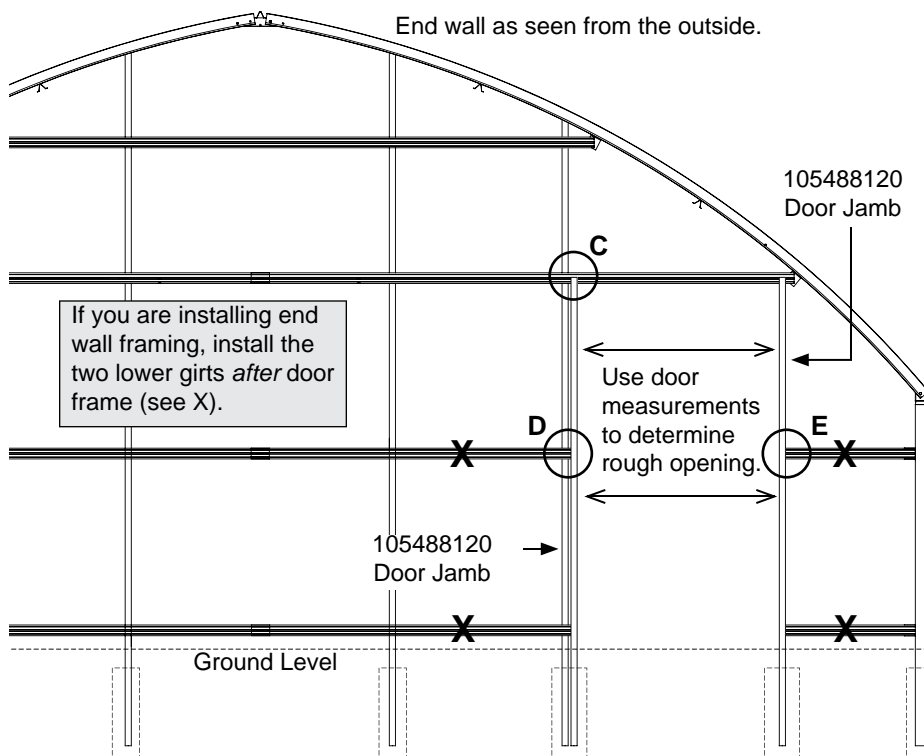
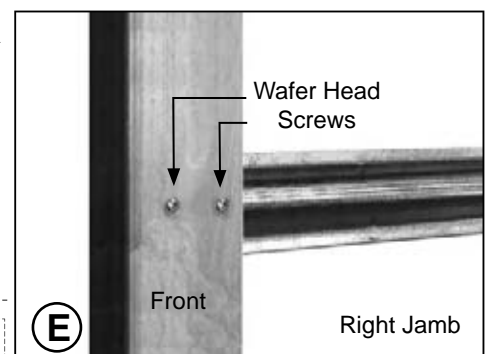
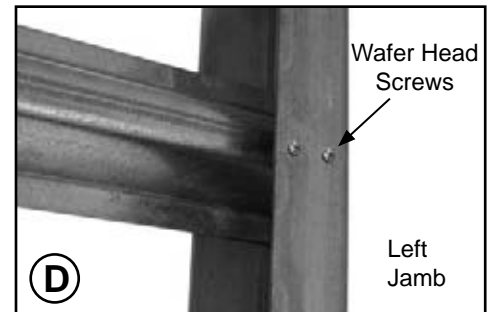
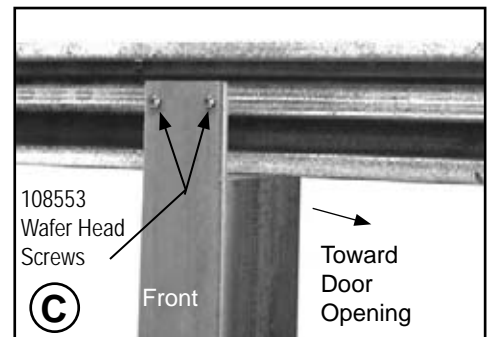
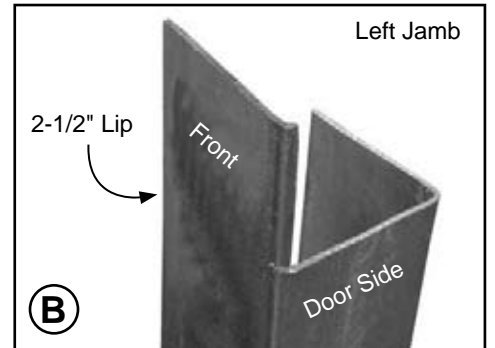
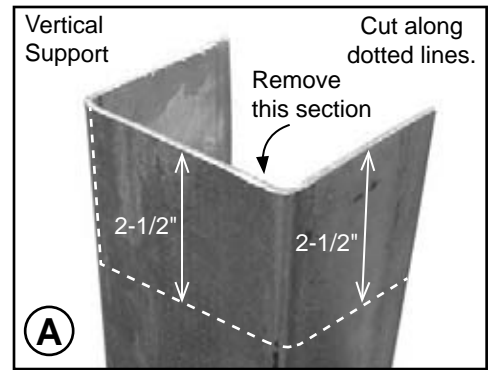

Door Frame Assembly

ASSEMBLING THE DOOR FRAME COMPONENTS (continued)

5. With the door jambs attached, measure and mark the height of the rough door opening. *Consult drawing below and door measurements.*

Measure from the finished grade to underside of header. If an optional threshold will be installed, adjust door opening measurement to account for the threshold installation. *Consult drawing on the following page and door measurements.*

6. Locate the remaining 105488120 C-channel for the header, measure the *outside-to-outside* distance of the door jambs, and cut the header to required length.
7. Using a metal saw, cut two 2" sections and bend the lip inward from both ends of the door header as shown to the right (see photos F and G). This creates two (2) lips and allows the header to be attached to the door jambs. **Open channel of the header points upward.**
8. Drill a 3/8" hole near each end of the header to create a drain hole for the header. This helps prevent water from collecting inside the door header (see photo H).
9. Position the header so that the two (2) lips on each side overlap the door jambs (see photo H) and align the bottom of the header with vertical support marks made in Step 5.
10. With the header level, attach the front and back of the header to the door jambs using wafer head screws. Reinforce the header by securing the bent lip to the door jamb using wafer screws as shown in photo H. (Or, customer-supplied bolts or Tek screws can be used.)

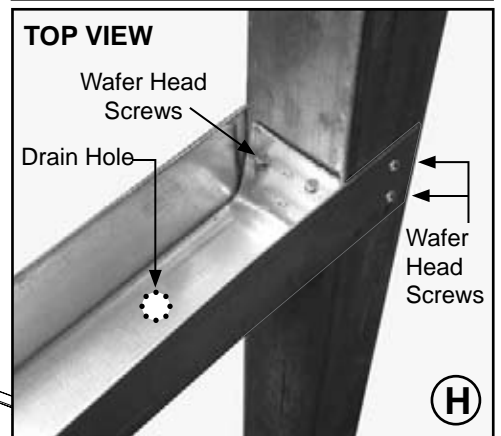
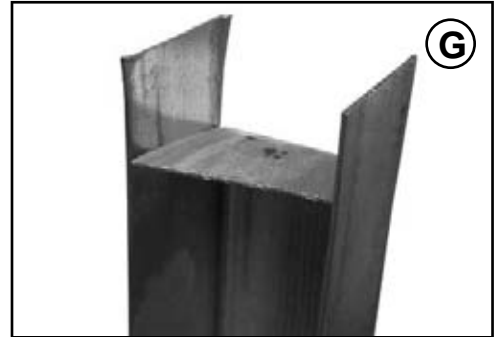
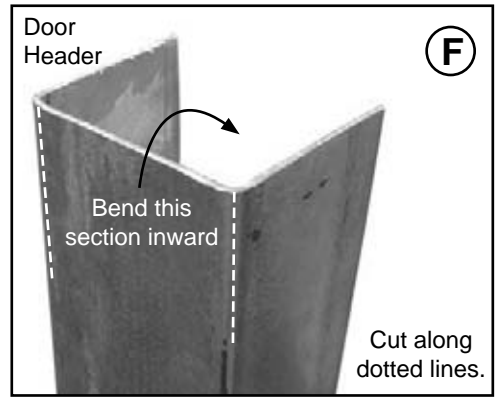

End frame and rafter are not included with any door frame kit.

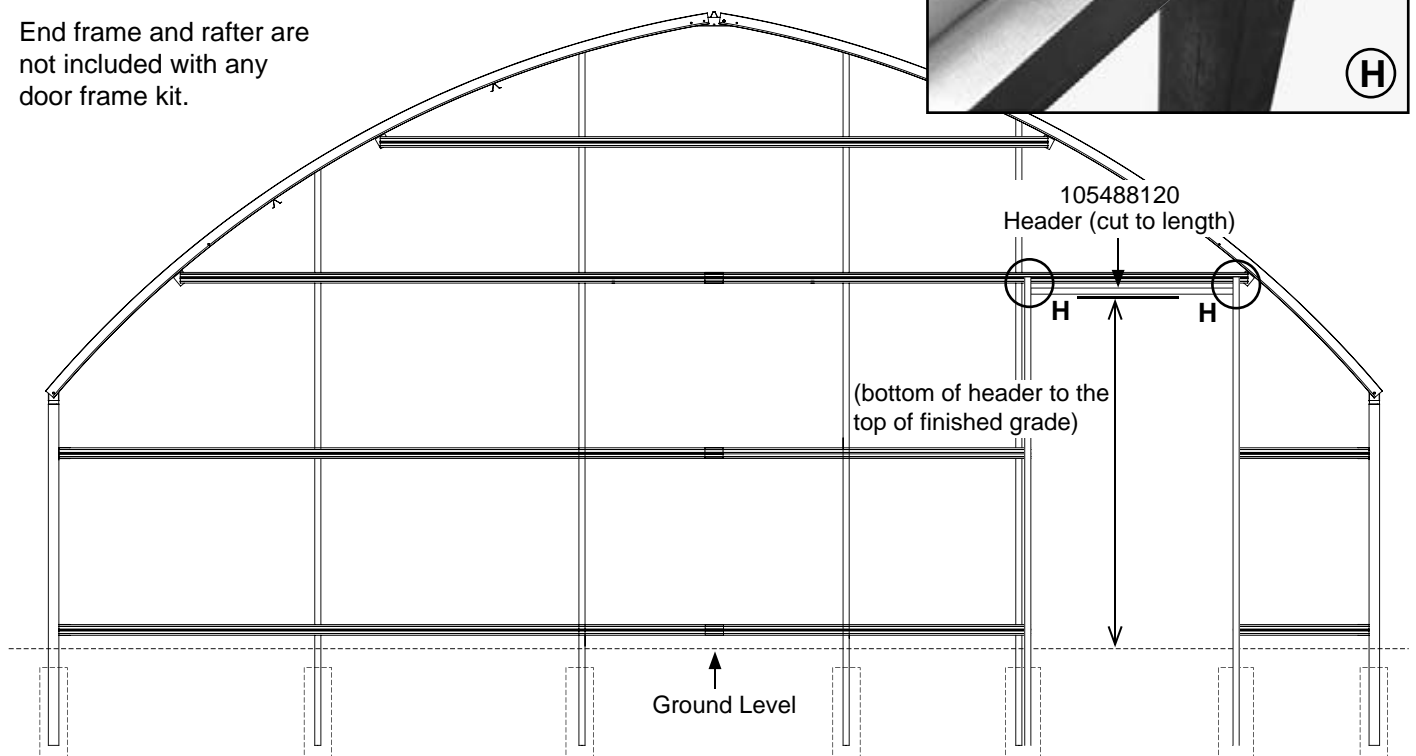

Door Frame Assembly

ASSEMBLING THE DOOR FRAME COMPONENTS (continued)

11. If an optional threshold is needed, using the 105488120 C-channel, repeat steps 6-7 and 9-10 to measure, prepare, and install the door threshold.

NOTE: Install the threshold with the **open channel facing down** as shown in photo I to the right. Remove the lip if needed or bend it back into the C-channel to prevent conflicts with the threshold installation.

12. After the door frame is square and assembled, secure the door jambs in the ground using concrete.

NOTE: Concrete should remain at least 2"-4" below ground level so that it does not interfere with construction, installation of other end wall components (if equipped), or the operation of the door.

13. After assembling the door frame, continue with the door installation. An additional purchase is required for the door; it is not included with the door frame kit.

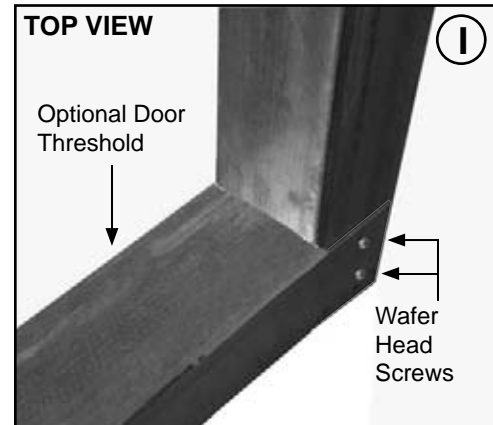
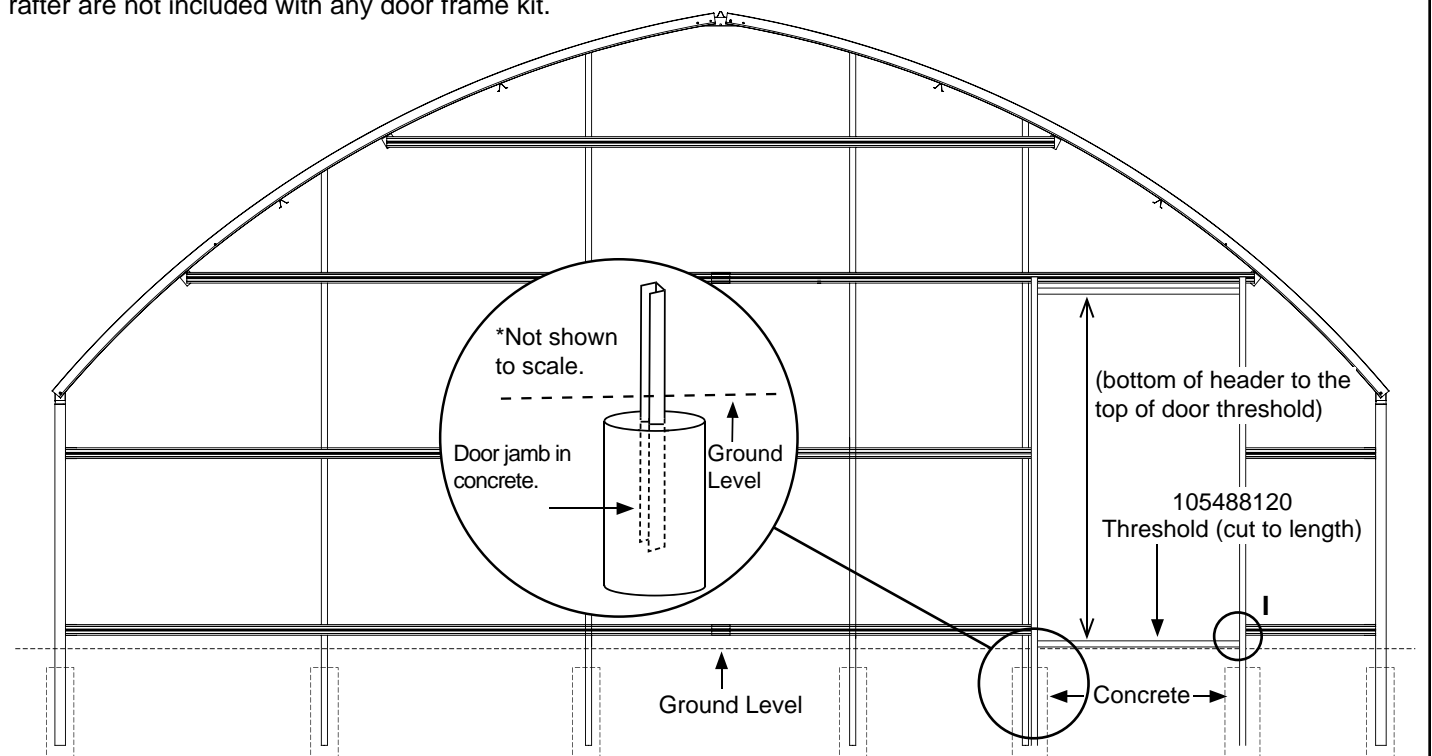

Diagram below shows the installation of the optional door frame threshold. End frame and rafter are not included with any door frame kit.



Entry Door Installation

ENTRY DOOR INSTALLATION

Install the entry door *before* installing the panels adjacent to and above the entry door opening when possible. If needed, consult the services of a qualified contract for assistance when setting and squaring the pre-hung door in the framed opening.

1. Set the door in the door opening.
2. Place wood shims or dimension lumber between the door jamb and the door frame to square the door in the opening. Square and shim door as needed.
3. Secure the entry door to the door frame using SRF15801 #14 self-tapping screws included with the hardware.

NOTE: If unable to use the self-tapping screws, purchase alternative fasteners locally.

4. Trim shims (if used) flush with the door jamb after the door is completely installed.

Sample
Pre-Hung
Door*



*Additional purchase required.

Entry door shown without threshold

Entry door shown with threshold

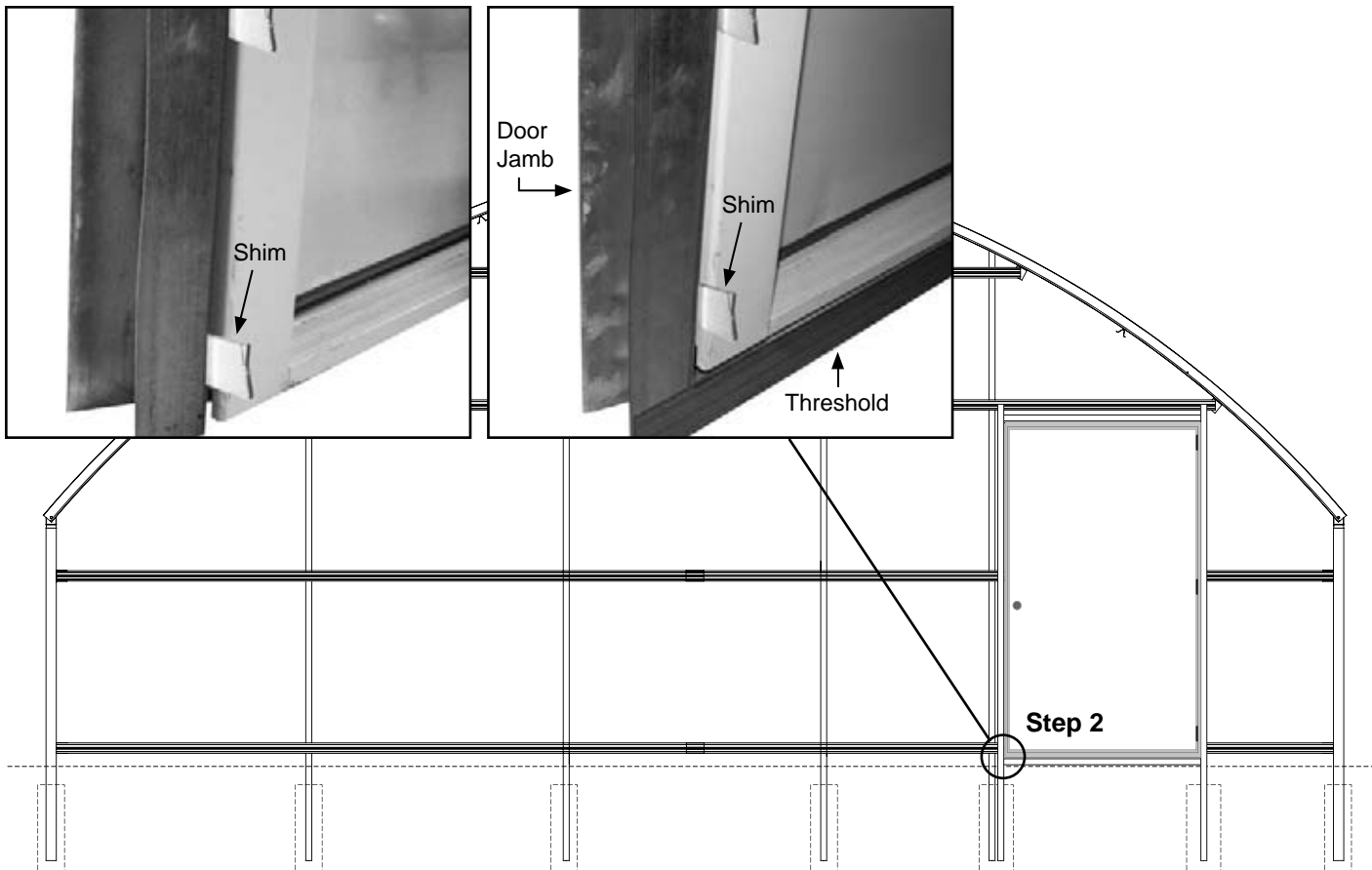

Shelter Care and Maintenance

SHELTER CARE AND MAINTENANCE

Proper care and maintenance of the door frame kit is important. Check the following items periodically to properly maintain the door and door frame:

- Regularly check the door frame and door to see that they remain secure and in good condition. Replace damaged parts if needed.
- Check connections and all fasteners to verify that they remain tight.
- Check the contents of the shelter to verify that nothing is touching the door frame or door that could cause damage or interfere with the door operation.
- ***Do not leave door partially opened or partially closed. Close door and secure with latch or prop door open to avoid personal injury or damage to the door.***
- For replacement or missing parts, contact you sales representative for assistance.



Space below is reserved for customer notes.

Quick Start Guide



QUICK START GUIDE

Door Frame Kit: R035A00014A

End frame, panels, end rafters, and door are not included with door frame kit.

Position the pre-hung door as desired without moving the vertical supports of the end wall frame when possible.

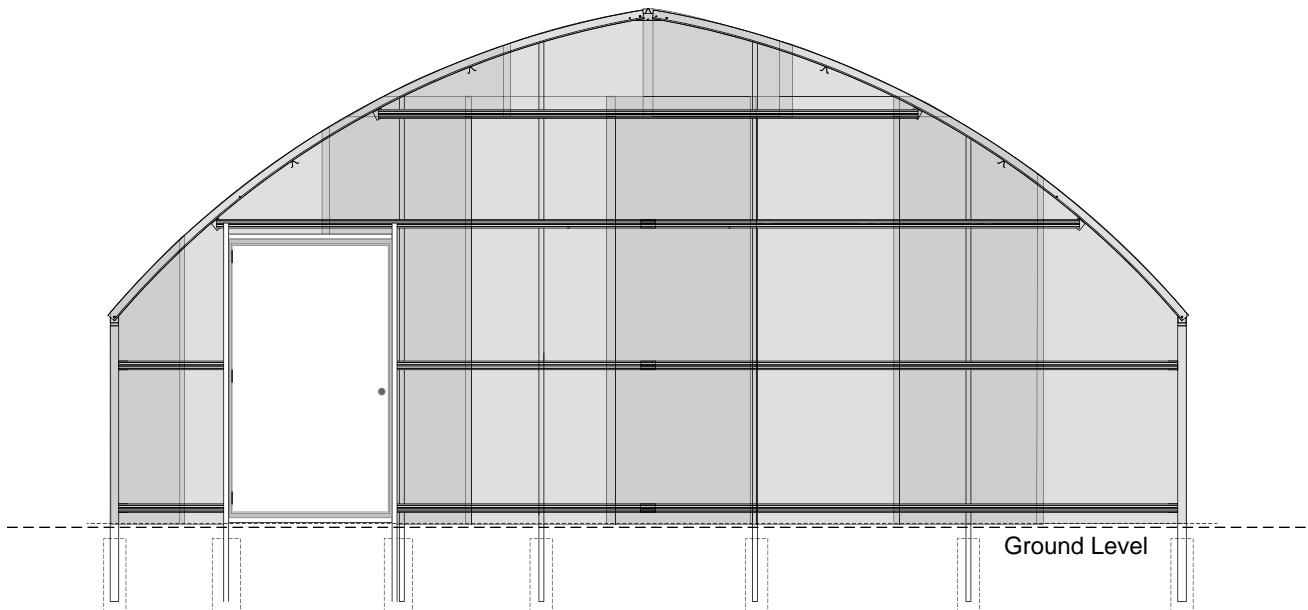
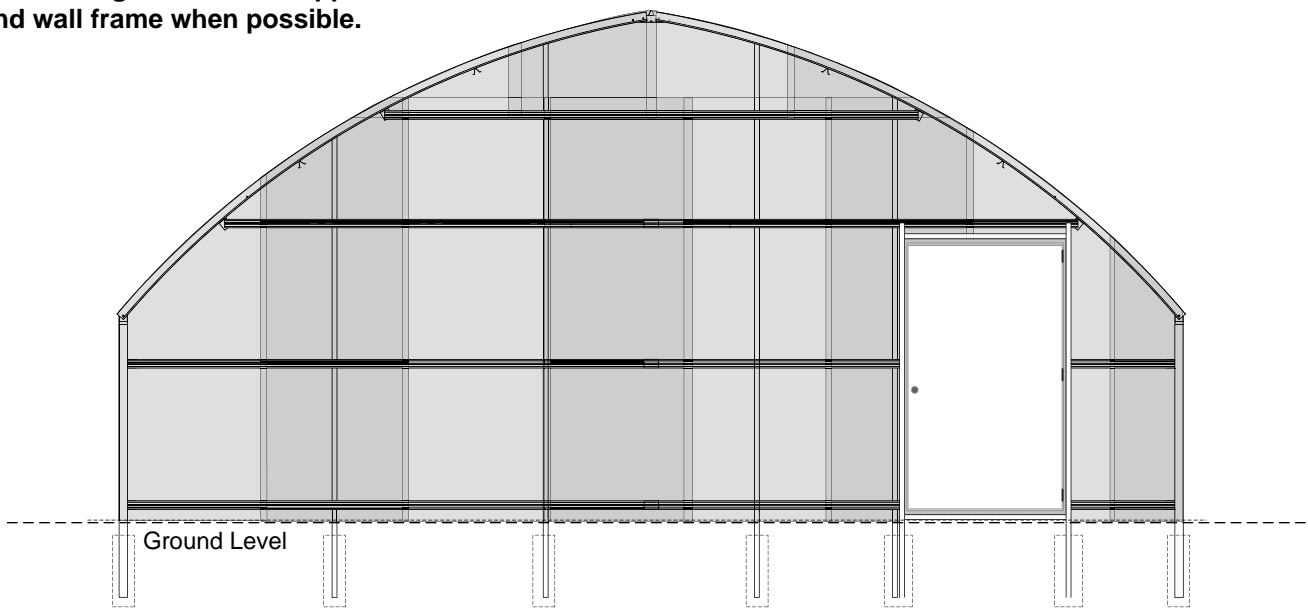
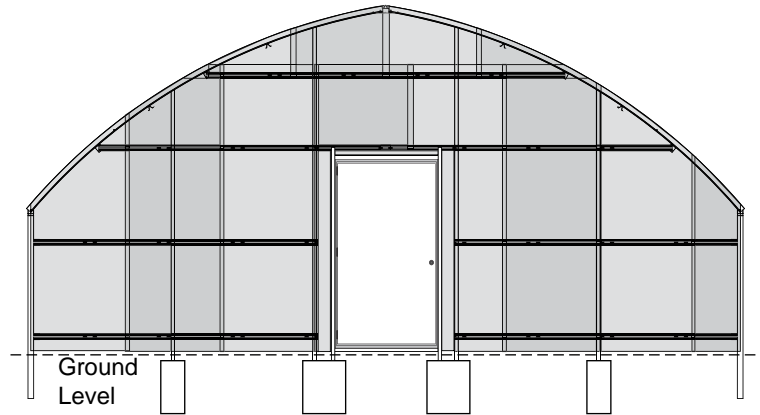

Door Frame Layout

Diagram below shows one possible door frame location.

Install door in a location that will not require the repositioning of the end wall vertical supports.

Always consider the installation of the end wall panel or panels before installing the door if panels are not installed yet.

Detail C

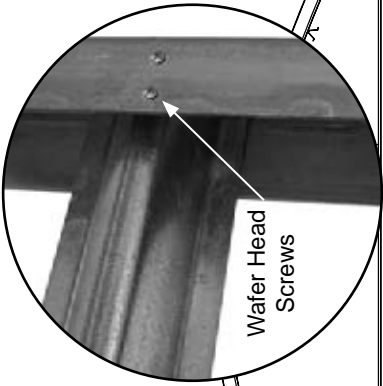

Detail B

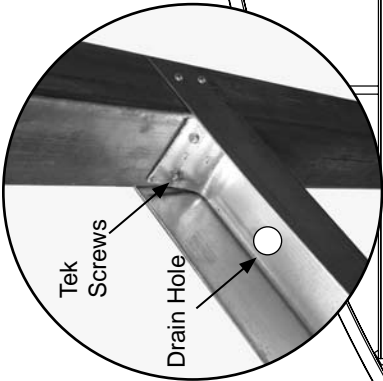

Detail E

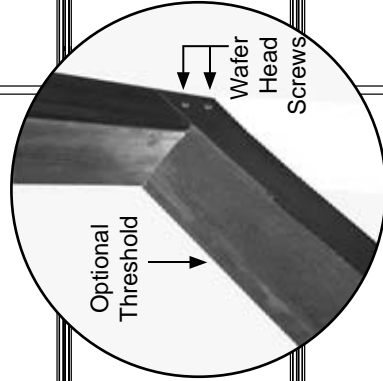

Detail A

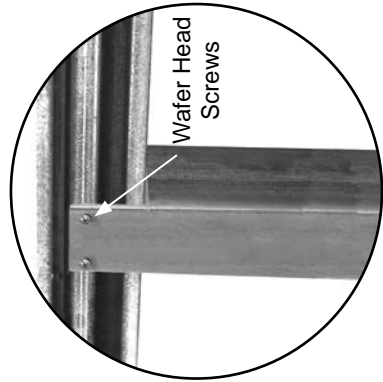

Detail D

