

# **MUST READ II PRIOR TO CONSTRUCTION!**

**IMPORTANT** – Fully read the installation manual prior to construction. Improper installation or failure to follow manufacturer's instructions, directions, illustrations and drawings could result in ultimate structural failure, and WILL VOID the manufacturer's warranty.



**CAUTION:** Do not allow snow or ice to build up on your shelter or canopy. Excessive weight on the structure may cause damage.

## **SPECIAL NOTICE!**

**ENGINEERING SERVICES & PRODUCTS COMPANY (ESAPCO) IS NOT RESPONSIBLE FOR PRODUCT FAILURE DUE TO FIRE OR EXCESSIVE WEATHER CONDITIONS SUCH AS SNOW, WIND, OR HAIL. CONSUMER, BY VIRTUE OF ASSEMBLY OF THE BUILDING KIT, ACKNOWLEDGES THE TEMPORARY DESIGN NATURE OF THE STRUCTURE.**

PLEASE CONTACT CUSTOMER SERVICE WITH ANY  
QUESTIONS OR CONCERNS.

# IMPORTANT!

ESAPCO shelters come in a variety of sizes and configurations, each requiring specific anchoring and reinforcement procedures employed to stabilize the structure. Some shelters already come with the anchoring and reinforcement components needed. Refer to shelter assembly instructions for the specific anchoring requirements of your shelter. Please contact our Customer Service Department with any questions or concerns you may have regarding the anchoring requirements of your shelter.

**Improper anchoring may cause shelter instability and ultimate structural failure and will void the manufacturer's warranty.**

## NOTICE:

**Important Safety Notice** - Do not attempt to install the cover and end panels on a windy day. Metal Frame must be completely assembled prior to cover installation.

Caution – *Snow, ice and other weighted material must not be allowed to accumulate on the film or fabric cover.* If film is left on year round, greenhouses must be heated during the winter season. *For all canopies and shelters, manual removal of ice and snow may be required.* Use an extension pole with a soft broom head. Insure there are no sharp edges that could cause damage to the cover.



**CAUTION:** Do not allow snow or ice to build up on your shelter or canopy. Excessive weight on the structure may cause damage.

**Never stand on structure or any component of the structure. Moisture on the film or fabric cover causes them to be extremely slippery.**

**DISCLAIMER: ESAPCO disclaims all responsibilities for any injury or damage caused by the building or accessories.**



## Canopy Anchor Kit 103599 Installation Instructions

Use this Canopy Anchor Kit 103599 to anchor your assembled canopy frame. This Canopy Anchor Kit is **not designed** for larger shelters or for use in sand or on hard surfaces such as asphalt or concrete.

**ATTENTION:** Installing ground stakes at every leg of the assembled frame is strongly recommended.

STEP 1: Remove the protective plastic sleeve.

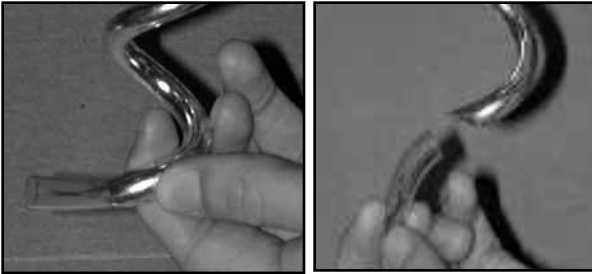

STEP 2: At each leg of the frame, measure 3' in the desired direction and twist a ground stake into the ground.

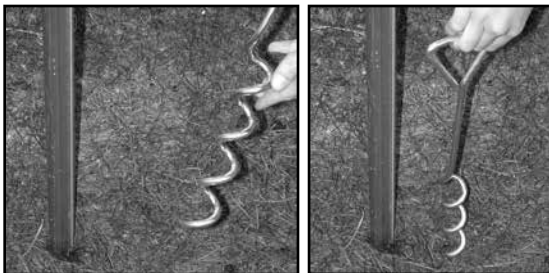

STEP 3: Twist stake clockwise until triangular top touches the ground.

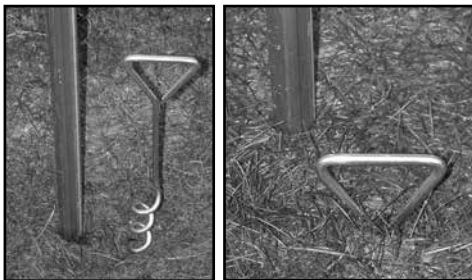

STEP 4: Secure long strap and attached S-Hook to the coupler.

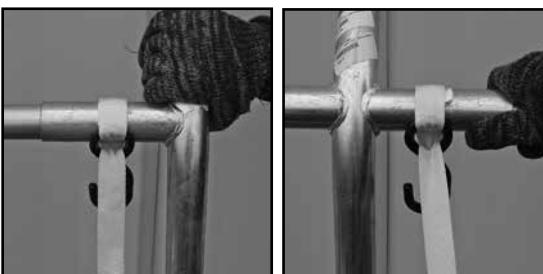

STEP 5: Insert the loose end of long strap into the ratchet and tighten to keep strap in place.

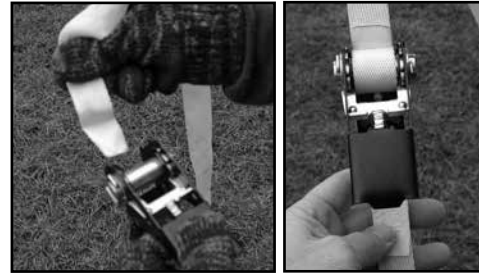

STEP 6: Hook the remaining S-Hook through the triangular top of the ground stake and tighten the ratchet.



**NOTE:** If the strap buildup is too great in the ratchet, loosen the ratchet, remove excess strap, and retighten the ratchet. DO NOT remove too much strap.

STEP 7: Repeat the steps as needed to secure each leg of the assembled frame to a ground stake. **DO NOT OVERTIGHTEN RATCHETS.**

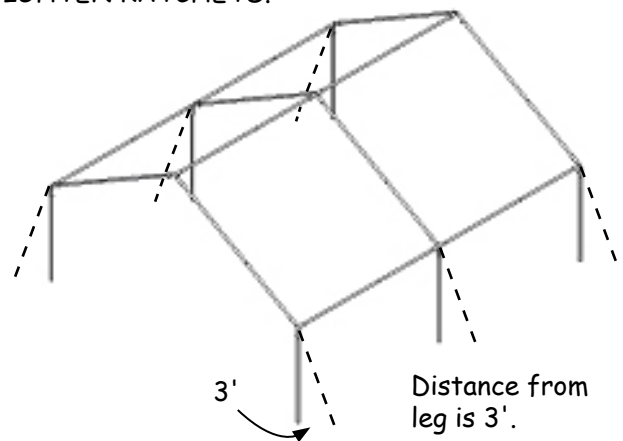

105587 Anchor Kit

# A

## EARTH ANCHOR ASSEMBLY (SKU: 105587) IN CONCRETE

If the optional anchor kit was purchased, use the diagrams below to properly install the auger-style earth anchor and to attach the brackets to the rafter pipes. For rafter pipe diameters greater than what is shown, consult the instructions that shipped with the kits to properly attach the anchor mounting brackets.

**ATTENTION:** Concrete must be used in loose or sandy soil types.

**IMPORTANT:** The length of the auger-style anchor shown in this example is 30".

Kits that include auger-style earth anchors of 48" and 60" are also available.

Rafter mounting foot is an additional purchase and is not included with any anchor kit or some shelters.

For best results, install the auger-style earth anchor as close to the rafter leg as possible.

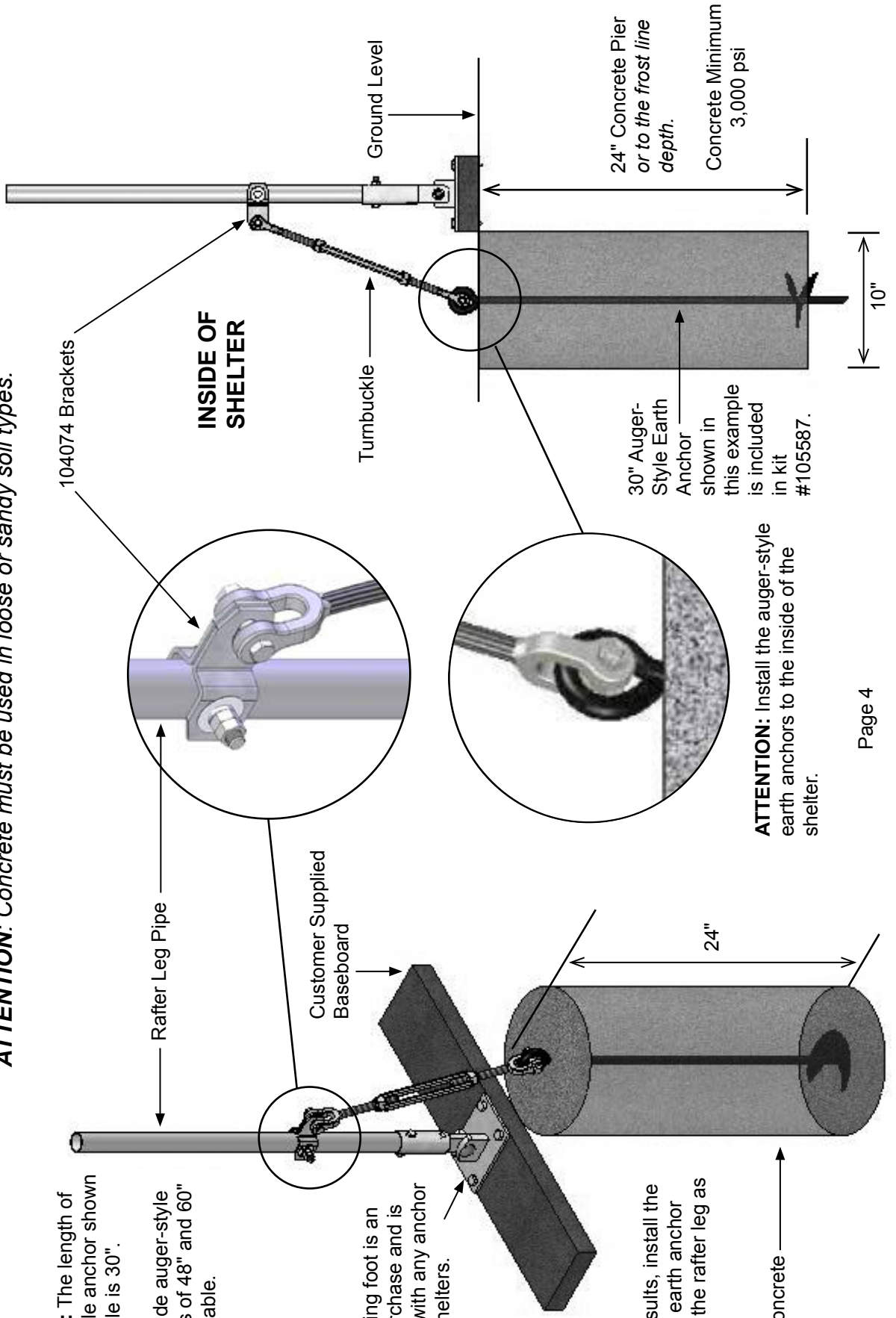

**ATTENTION:** Install the auger-style earth anchors to the inside of the shelter.

# B

## EARTH ANCHOR ASSEMBLY WITHOUT CONCRETE

If the optional anchor kit was purchased, use the diagrams below to properly install the auger-style earth anchor and to attach the brackets to the rafter pipes. For rafter pipe diameters greater than what is shown, consult the instructions that shipped with the kits to properly attach the anchor mounting brackets.

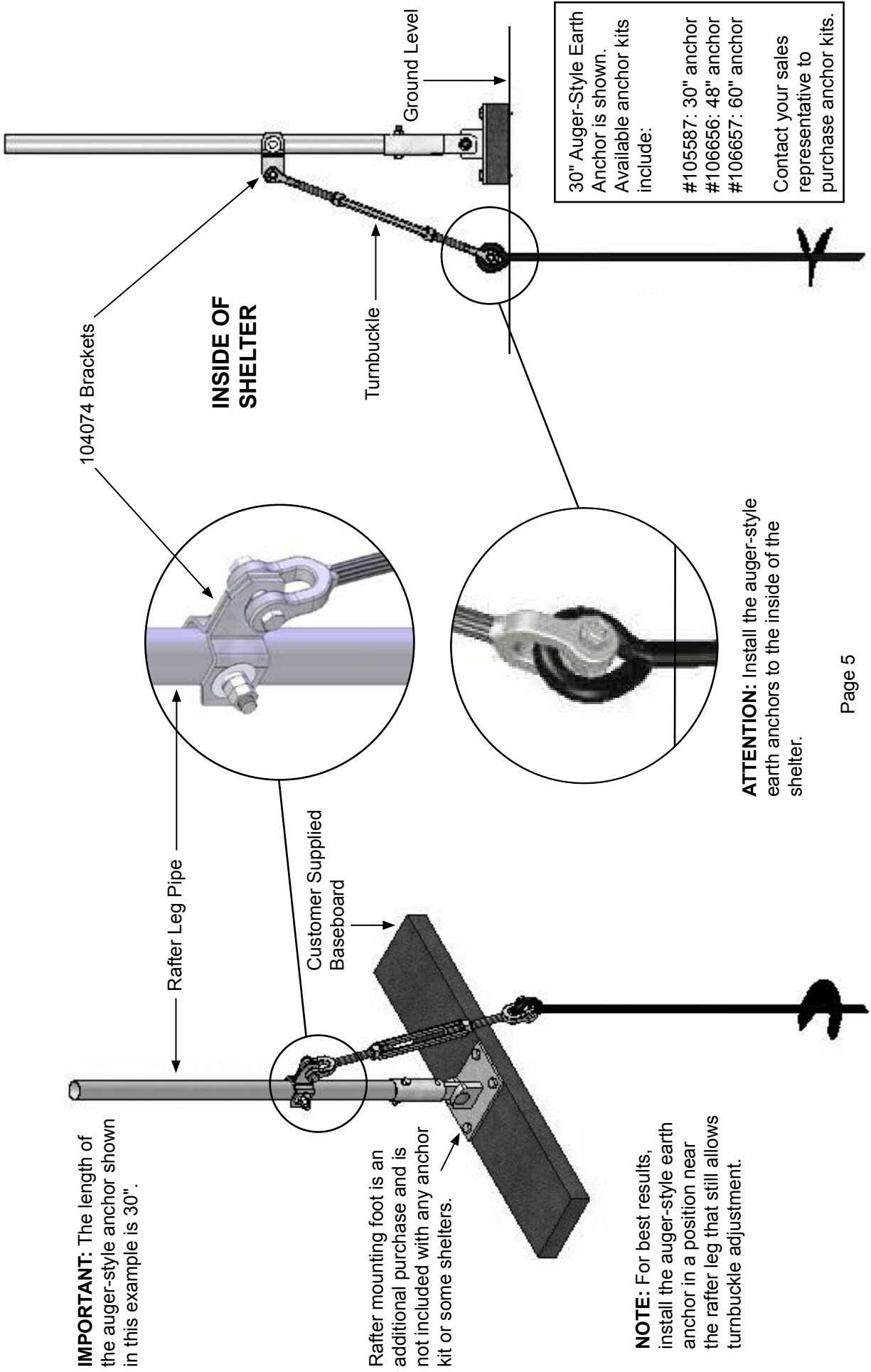

**IMPORTANT:** The length of the auger-style anchor shown in this example is 30".

Rafter mounting foot is an additional purchase and is not included with any anchor kit or some shelters.

**NOTE:** For best results, install the auger-style earth anchor in a position near the rafter leg that still allows turnbuckle adjustment.

30" Auger-Style Earth Anchor is shown.  
Available anchor kits include:  
#105587: 30" anchor  
#106656: 48" anchor  
#106657: 60" anchor  
Contact your sales representative to purchase anchor kits.

**ATTENTION:** Install the auger-style earth anchors to the inside of the shelter.



# B-1

## EARTH ANCHOR ASSEMBLY SHOWING A 60" AUGER-STYLE ANCHOR (KIT #106657)

### POSITION ANCHOR INSIDE SHELTER

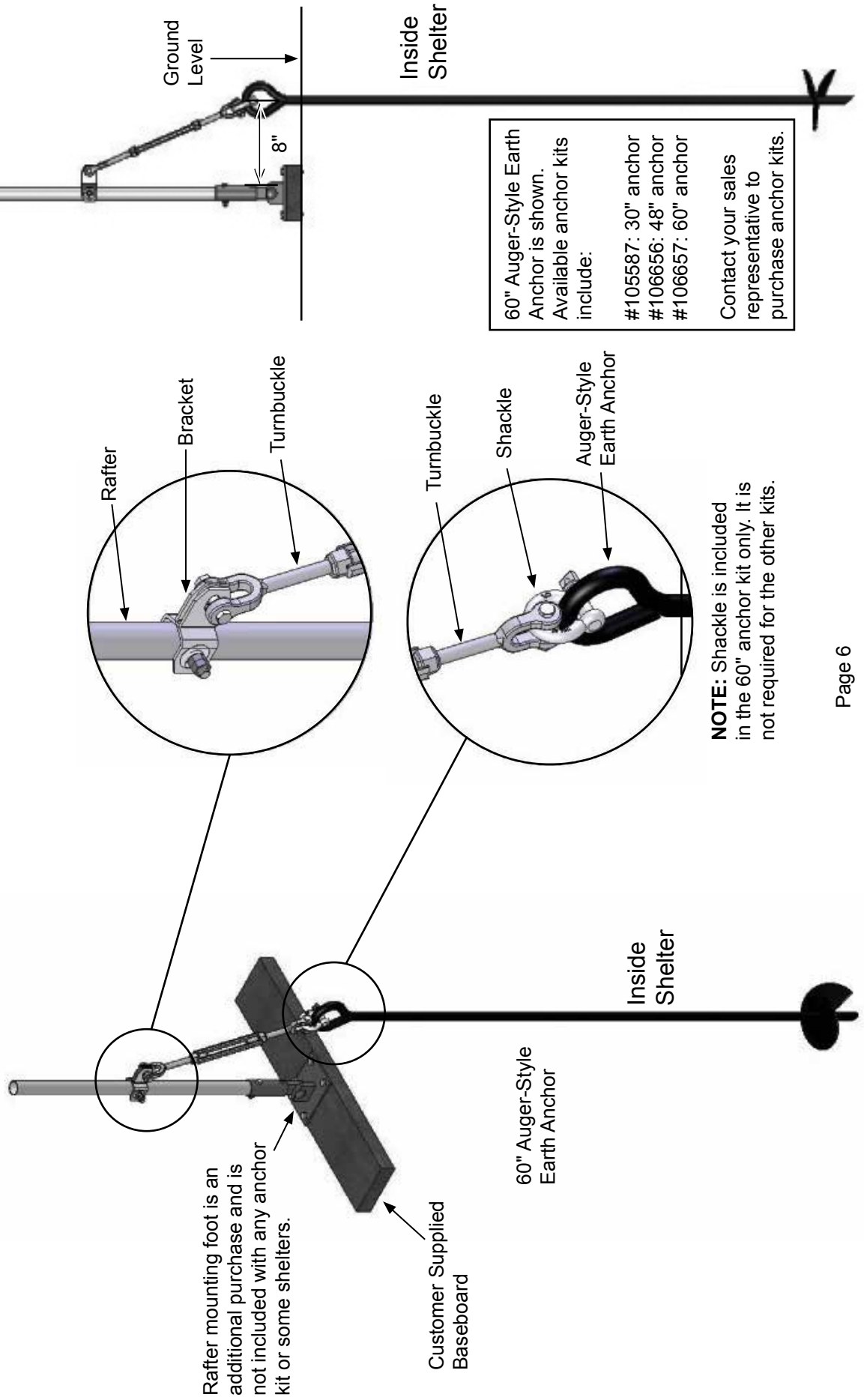

Rafter mounting foot is an additional purchase and is not included with any anchor kit or some shelters.

Customer Supplied Baseboard

60" Auger-Style Earth Anchor

Inside Shelter

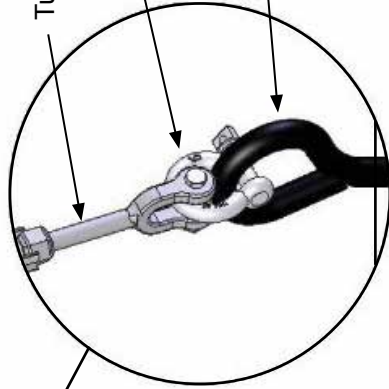
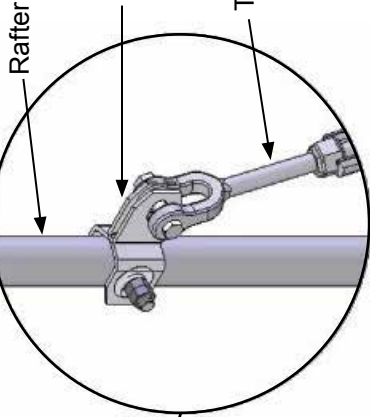

**NOTE:** Shackle is included in the 60" anchor kit only. It is not required for the other kits.

60" Auger-Style Earth Anchor is shown. Available anchor kits include:  
#105587: 30" anchor  
#106656: 48" anchor  
#106657: 60" anchor  
Contact your sales representative to purchase anchor kits.



## Engineering Services & Products Company

### SHELTER AND GREENHOUSE EQUIPMENT PACKS

Equipment packs help control and manage the interior environment of many shelter types. When used in greenhouses, equipment packs improve growing conditions and help lengthen the growing season. For other shelters, the fans, heaters, thermostats, and vents included in an equipment pack all help control temperature and moisture and improve air quality.

**ATTENTION: Some greenhouses and shelters do not include equipment packs.** To purchase an equipment pack for your greenhouse or shelter, contact your sales representative.

Whether an equipment pack was included with or purchased as an addition to your shelter or greenhouse, equipment packs help achieve the results and maintain the conditions you want all year long.

### FREQUENTLY ASKED QUESTIONS

"Where should I install the fans for my shelter?" "At what end of the greenhouse are shutters installed?" "Are circulation fans attached to the end wall?" With feedback from customers like you, our support team has provided answers to these and other frequently-asked equipment pack questions.

*Our product support team estimates that over 90% of customer questions about equipment packs are answered within these pages.*

### GETTING STARTED

Many factors must be considered before you install the items contained in any equipment pack. The following information provides suggestions for the placement and installation of accessories.

Read and follow all instructions supplied with each accessory (if provided) and follow all building codes specific to your region.

If you do not know how to properly install these items, obtain the services of a professional who is familiar with the installation and use of similar items and related equipment.

Equipment packs are designed according to building square footage only. Climate, growing zones, shelter use, and other factors must be considered when selecting, installing, and using fans, heaters, and vents. When in doubt, consult a professional for answers to questions that are beyond the scope of this document.

In addition to other sources, greenhouse information is found on the Internet or at your local extension office.

**ATTENTION:** To prevent personal injury or damage to greenhouse and shelter contents, always consult the services of an experienced professional before installing and using the items contained within these equipment packs.

### SAFETY PRECAUTIONS

Fans and Motors:

Over heating due to excessive dirt, overloading, poor ventilation could ignite combustible materials. Provide plenty of ventilation for motors and keep them clean.

- Maintain a clearance of 18 inches between motors and any combustible material.
- Make sure that fans are wired by a qualified electrician.
- Inspection of fans and motors must be part of routine maintenance.
- Check voltage and amperage to see if it corresponds to motor nameplate.
- Do not install fans or other electrical devices where water from automatic sprinkler systems will shower the motors or get pulled through the fan.

Thermostats:

The placement and position of thermostats within a shelter depends on the equipment that the thermostat controls and for greenhouses, the plants that are grown. Always consult the services of a professional familiar with how you intend to use your greenhouse or shelter.

- *All wiring must be completed by a licensed electrician and according to local building codes.*
- *Consult with a professional familiar with thermostats, the installation of thermostats, and the equipment that thermostats control if needed.*

# Equipment Pack Safety Information

## Heaters:

Always follow the installation instructions that shipped with the heater.

- Combustion type heaters must have adequate clearance from combustible materials as directed in their installation manuals.
- Portable heaters often do not contain safety devices that prevent overheating and should not be left unattended.
- All heating units must be well supported. The supports should be designed to eliminate any excess vibration or stress regarding the shelter frame.
- Some heaters require venting to the outside.
- Gas piping and connections to all heating equipment should comply with local codes and manufacturer requirements. *All gas heaters must be installed by a qualified installation and service agency.*

## Ventilation Fans:

- Fans and shelter size determine the number of fans required. Adequate fans should be used to provide a spacing of not more than 25 feet along the exhaust side of the greenhouse.
- When possible, the fans should be located on the downwind side of the shelter. If the fans must be located on the windward side, the ventilation rate should be increased at least 10 percent, and fans having at least ¾ HP (or larger) motors should be used.
- The fan should have at least 1-1/2 times the diameter of clear space between their discharge opening and the nearest obstruction, such as a building wall.
- Fan blades should be guarded properly or installed in a location that prevents people or animals from touching any moving parts.
- When fans face fans of adjacent and separate greenhouses or shelters within 15 feet of each other, they should be offset from each other so the exhausting air from one fan will not blow directly against that of another fan.

## ADDITIONAL FRAMING FOR ACCESSORIES

Depending on the shelter, it may be necessary to alter the framing to properly install the components of an equipment pack. Consulting the diagrams in this document and the frame assembly instructions for the shelter will help you anticipate the installation of equipment pack components.

Determining the locations of specific equipment pack components *before* you complete the assembly of your shelter saves time and can prevent delays in construction.

To prevent injury and property damage, always consult a construction professional *before* altering the design of a structure or adding framing for accessories. All customer-supplied materials and framing must be adequate to support the weight of the accessory and the forces resulting from the operation of that accessory.

**NOTE:** If the equipment pack is purchased to use in an existing greenhouse or shelter, ask your sales representative about additional frame materials and suggestions.



**Placement of Accessories:**

Below are suggested locations for equipment packs based on the square footage of a greenhouse or shelter.

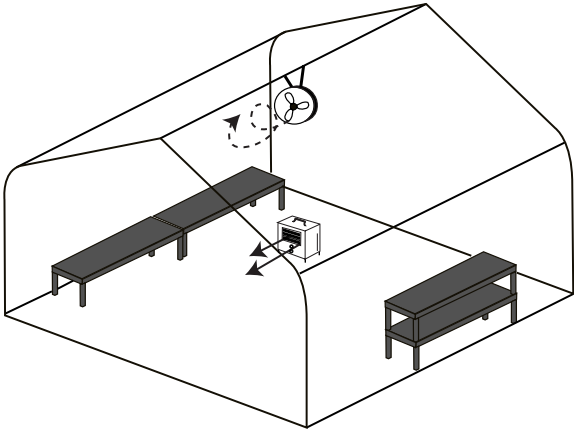

**Small Equipment Pack:**  
Ideal for shelters with 42-100 square feet.

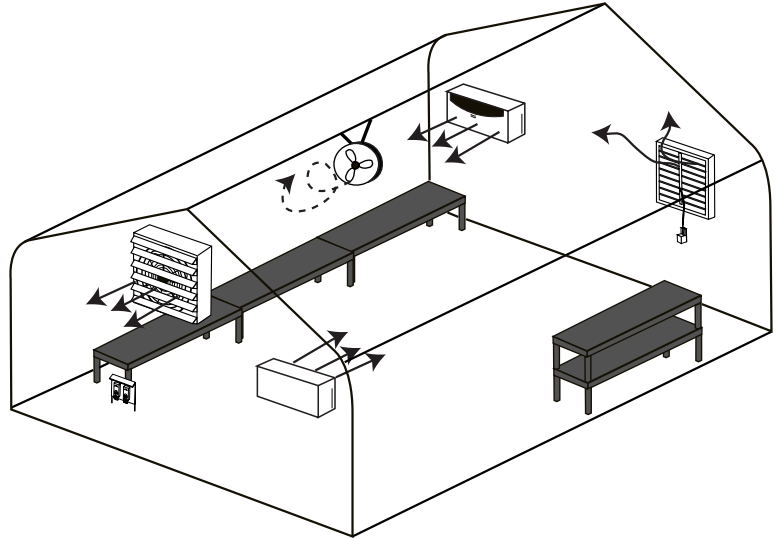





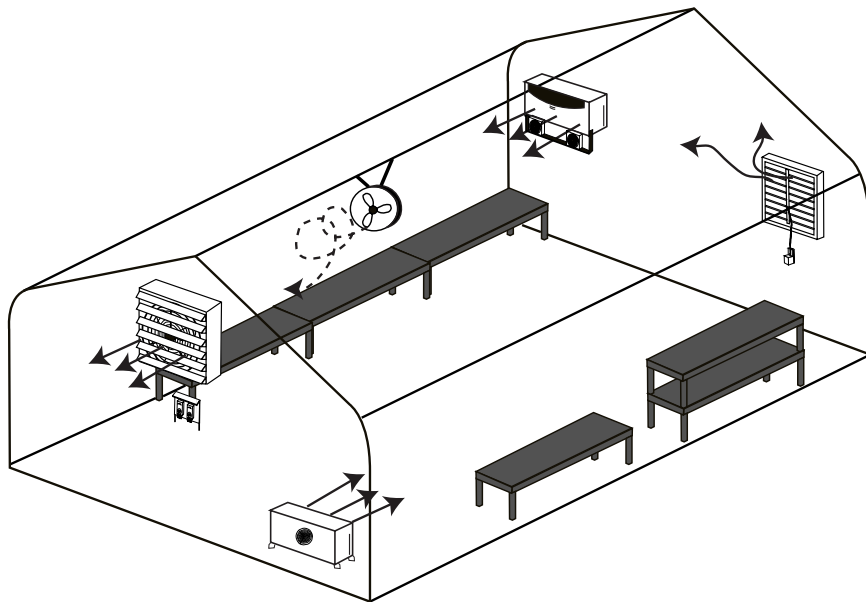



**Medium Equipment Pack:**  
Ideal for greenhouses and shelters with 100-200 square feet.

**ATTENTION:** It may be necessary to add frame members or change the locations of frame members when adding an equipment pack to an existing greenhouse or shelter.



**Large Equipment Pack:**  
Ideal for greenhouses or shelters with 200-300 square feet.

**Accessory Key**

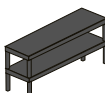
-  Air Circulation Fan
-  Dual Voltage Thermostat
-  Electric Heater
-  Blue Flame Heater (Front and Back View)
-  Blue Flame Heater w/Control Blower (Front and Back View)
-  Direct Vent Heater
-  Direct Vent Heater w/ Blower Kit (Front and Back View)
-  Motorized Intake Shutter
-  Exhaust Fan w/ Shutter
-  2-Tiered Cedar Bench

**Placement of Accessories:**

Below are suggested locations for equipment packs based on the square footage of a greenhouse or shelter.

**ATTENTION:** It may be necessary to add frame members or change the locations of frame members when adding an equipment pack to an existing greenhouse or shelter.

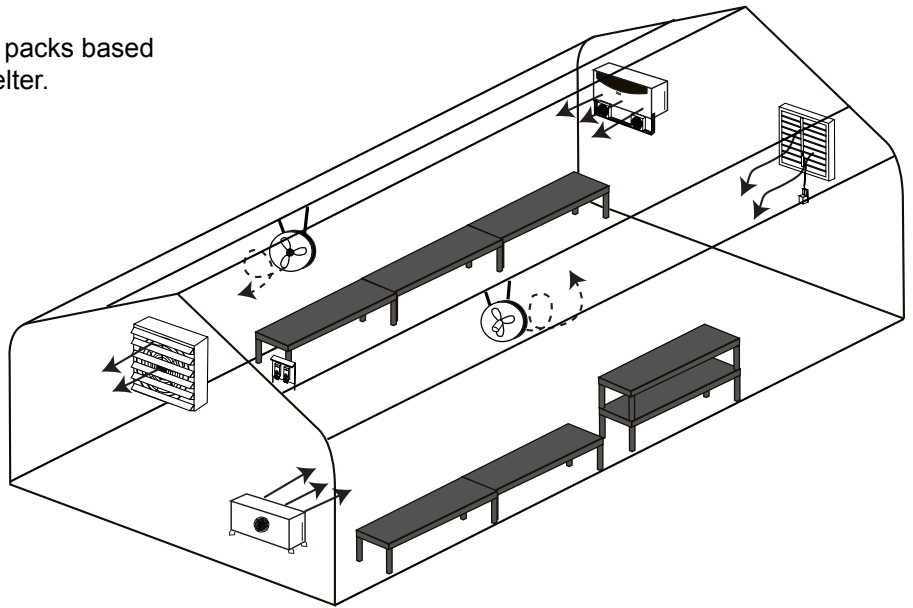

**Extra Large Equipment Pack:**

Ideal for shelters and greenhouses with 300-400 square feet, or within any zone where additional heating or cooling is required.

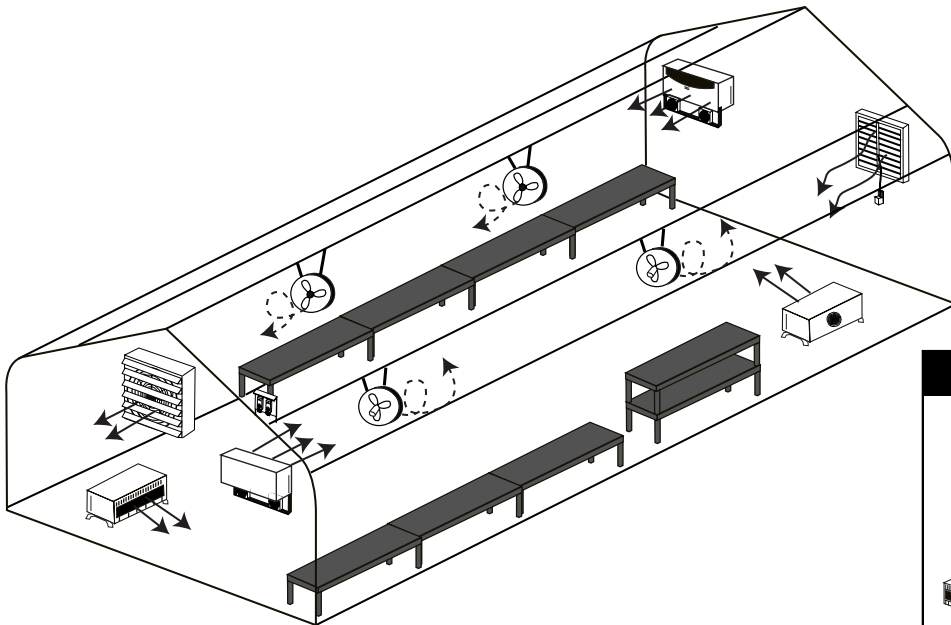

**Jumbo Equipment Pack:**

Ideal for shelters and greenhouses with 400-700 square feet, or within any zone where additional heating or cooling is required.

Accessory Key	
	Air Circulation Fan
	Dual Voltage Thermostat
	Electric Heater
	Blue Flame Heater (Front and Back View)
	Blue Flame Heater w/Control Blower (Front and Back View)
	Direct Vent Heater
	Direct Vent Heater w/ Blower Kit (Front and Back View)
	Motorized Intake Shutter
	Exhaust Fan w/ Shutter
	2-Tiered Cedar Bench



## **Equipment Pack Installation Information**

### **Exhaust Fan Installation:**

A sturdy, framed wall opening should be prepared in advance to the size indicated for your exhaust fan. The framing structure must be strong enough to secure the fan weight and the vibration of the fan when in use.

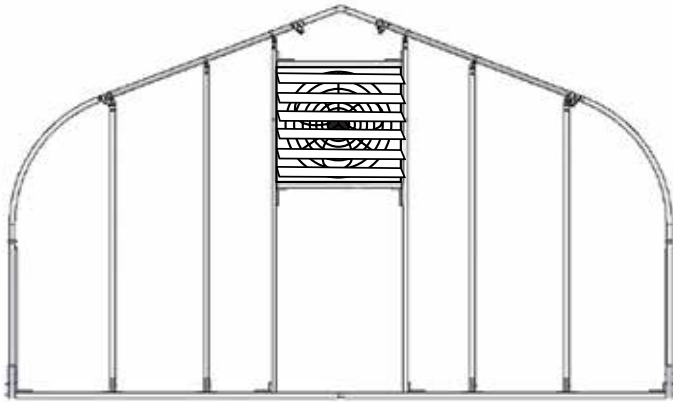

Ideal location for exhaust fan is opposite of the door and as close to the peak of the greenhouse as possible. View is from outside the shelter.

**NOTE:** Verify that the louvers (if applicable) will not be obstructed when operating.

1. Frame an opening in the shelter frame for the fan. (If end wall panel is film or polycarbonate, you must cut through the material.) *Do not remove any critical frame structure. The fan must be properly located for best results.*
2. With lag bolts for wooden frames or nut, bolt, and lock washers for steel frames, secure the fan using the mounting holes provided in each corner of the fan.
3. Seal the end panel around the fan with weather stripping or sealant if desired. (Materials to seal the end panel must be supplied by the customer.)
4. Wire the fan. Electrical wiring must be done by a licensed electrician. Follow all local building codes.

**NOTE:** Mounting, framing, and sealing materials are not included with the fan; these are supplied by customer.

### **Intake Shutter Installation:**

For proper ventilation, intake shutters are placed on the end of the shelter opposite the exhaust fans.

The shutters may be equipped with a thermostat to automate the louvers to open when ventilation is necessary.

Shutters can be fitted into a wall opening from the inside or over an opening on the outside.

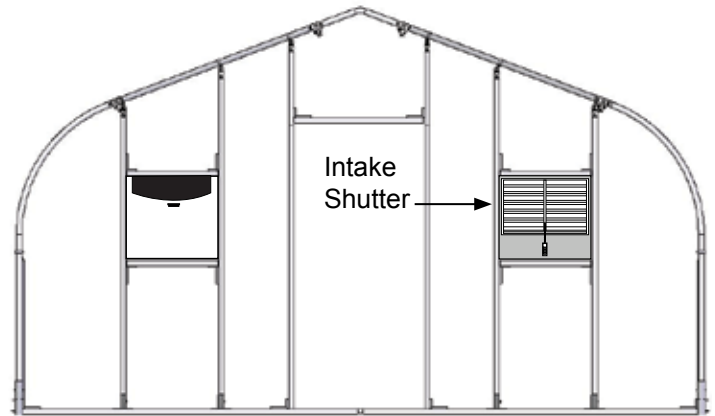

The drawing shows one example of the intake shutter and heater placement for a shelter. View is from inside shelter.

The shutter kits are easy to assemble and install. *Follow the installation steps included with the shutters.*

**NOTE:** Verify that the louvers will not be obstructed when operating.

1. Frame an opening in the shelter frame for the shutter. (If end wall panel is film or polycarbonate, you must cut through the material.) *Do not remove any critical frame structure. The shutter must be properly located for best results.*
2. With lag bolts for wooden frames or nut, bolt and lock washers for steel frames, secure the shutter using the mounting holes provided in each corner of the shutter.

**NOTE:** Mounting, framing, and sealing materials are not included with the fan; these are supplied by customer.

## Heater Installation:

When possible, install the heater out of reach of people. The direction of air flow should not be restricted by machinery, beams, etc., and the air flow should move along exposed walls, rather than blowing directly at them.

When more than one heater is used in an area, the heaters should be arranged so that the air discharge of each heater supports the air flow of the others to provide best circulation of warm air.

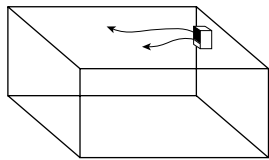

**All heaters must be installed by a licensed technician. Read all instructions included with your heater.**

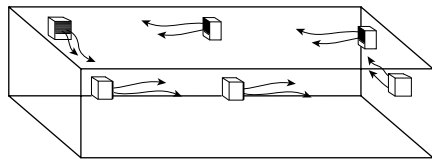

The information below describes one way to install a heater. *Follow the installation steps included with the heater.* View is from inside the shelter.

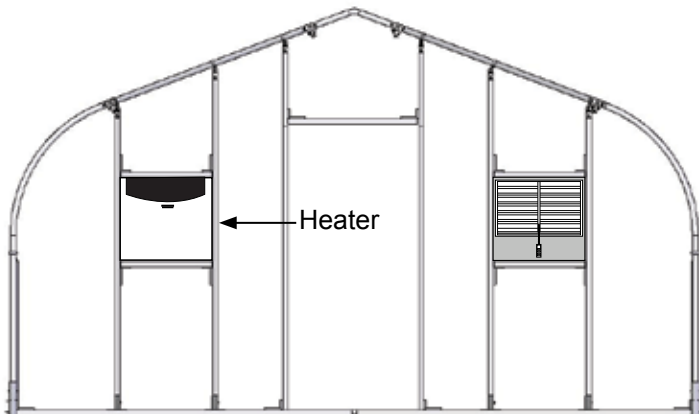

1. Frame an opening in the shelter frame for the heater if needed. *Do not remove any critical frame structure. Consult the heater installation instructions for proper installation requirements.*

*Some heaters may not require a vent to the outside. Consult the installation instructions for that heater.*

2. With lag bolts for wooden frames or nut, bolt and lock washers for steel frames, secure the heater to the frame.

**NOTE:** Mounting and framing materials are not included with the fan; these are supplied by customer. In some instances, you must construct a proper support for the heater. Frame structures of some shelters may not support the weight of a heater. Contact a professional contractor if needed to properly install the unit.

## Circulating Fan Installation:

When the fan is to be used as a circulation fan and suspended overhead, the fan must be mounted to remain rigid and not allowed to swing. The hangers or support system should be attached to the building structure and made of material strong enough to support the fan weight and to keep the fan in place.

1. Choose your fan location so there is a minimum of five (5) feet of unrestricted air flow to the back side of the fan.

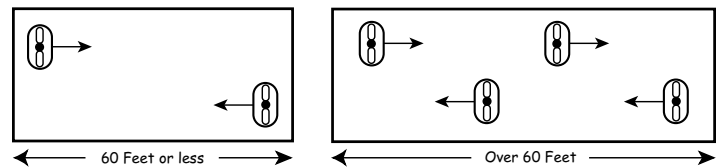

2. If the fan has a mounting bracket, mount the fan to the building structure so that the fan remains rigid. Use the hardware included with the fan. (Some fans may not include additional hardware.)
3. When the fan is suspended using chain, wires, straps, etc., feed the chains through the top of the fan in two locations to prevent the fan from "swinging" excessively.

**NOTE:** The motor wiring should be secured to the fan in a manner that will not allow the wiring to be pulled into the fan blades. Consult a professional electrician if needed.

## Thermostat Installation:

In greenhouses, install the thermostat to sense plant temperature. For other shelters, install thermostats in locations away from the direct heat of the heater or away from uninsulated walls.

To get the desired temperature, thermostats should be located at plant height near the center of the growing area where they are not influenced by drafts or sidewall cooling.

Install thermostat so that it can be raised or lowered for different crops.

Two Thermostats: It is best if both thermostats are located together and protected from direct contact with sunlight and water. Mount the thermostat(s) to a piece of wood with a top.

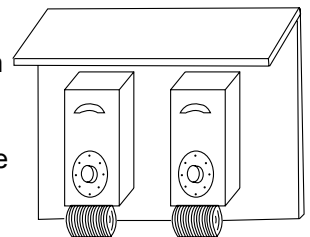

Connect one thermostat to your exhaust fan and the other to your motorized shutter. Set the motorized shutter thermostat 6° cooler than the exhaust fan so it is open when the fan turns on.

*All wiring should be completed by a licensed electrician.*