



ClearSpan™
Twin-Wall Polycarbonate End Panel Kit
30' Wide & 35' Wide

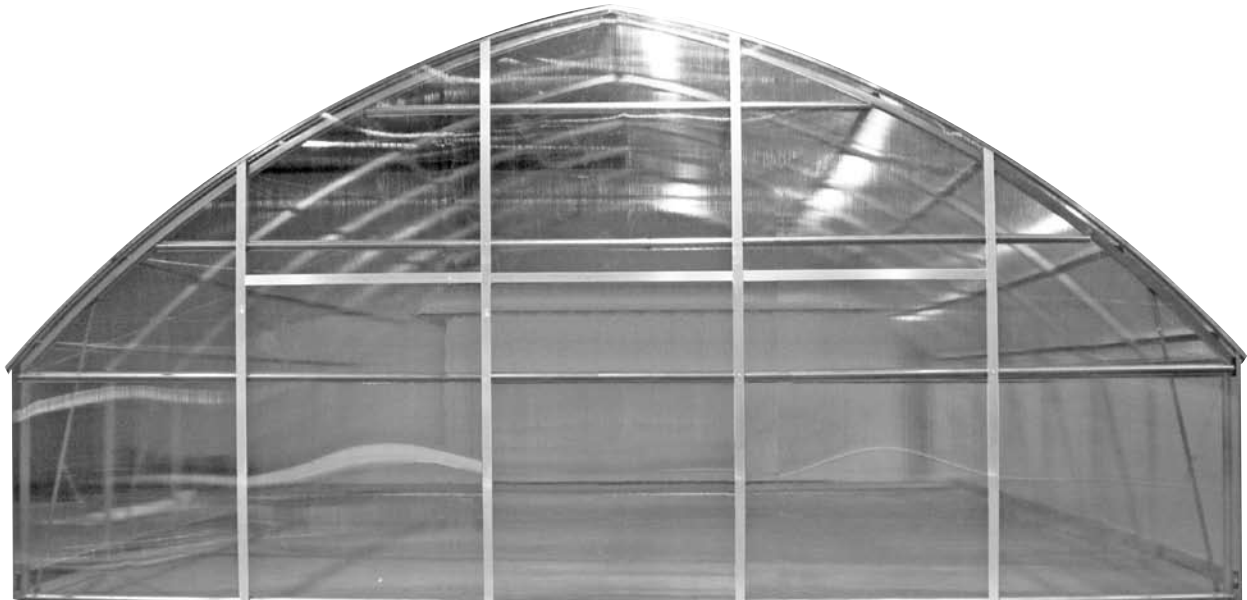

Diagram shows a sample end panel kit for a frame. Actual panel positions and sizes for your end panel package may differ from what is shown. Photo is used as an example only. Consult the diagrams in the Quick Start section of this guide for your building to see the panel sizes and layout.

©2010 ClearSpan™
All Rights Reserved. Reproduction
is prohibited without permission.

STK#
R030B00008 (30' Wide)
R035B00008 (35' Wide)

Revision date: 06.04.10

Table of Contents

Important Information	3
End Panel Installation	5
Shelter Care and Maintenance	9
Quick Start Guide	10
Polycarbonate Panels - 30' Wide	11
Polycarbonate Panels - 35' Wide	12
Notes.....	13

TWIN-WALL PC PACKAGE: READ THIS BEFORE YOU BEGIN

The twin-wall PC package is designed to attach to either the R030B00001 end frame for the 30' wide roll-form, or the R035B00001 end frame for the 35' wide roll-form building *after the end frame is assembled*.

Choose one of the following options to continue:

- If you purchased but have not assembled the end frame, stop here, return to the end frame instruction guide, and continue with those instructions.
- If you did not purchase an end frame for a roll-form building but plan to construct an end frame using customer-supplied materials, review these instructions before constructing the end frame to better prepare for the installation of the panels included in this PC package.

After assembling the end frame, continue with these instructions to attach the corrugated panels.

ATTENTION: If you purchased an optional door kit, consult those instructions and proceed as instructed. In most instances, the end frame and door frame are constructed *before* end panels are installed. This allows for the placement of panels as determined by the position of the door or doors.

It is the responsibility of the owner/contractor to adjust the position of the end panels based on the end frame and the position of the installed door or doors. Consult the services of a qualified contractor to install the panels if needed.

IMPORTANT: Some diagrams throughout this manual show the outside edges of the end panels installed aligned with the outside edge of the end rafter legs or ground posts.

For buildings that include sidewall polycarbonate panels and hat channel secured to the frame, shift the position of the end panels as needed so these panels meet the sidewall panels to create a finished corner. See the diagrams in the Quick Start section for sidewall examples.

FRAMING: *None of the frame members (rafter, ground posts, etc.) supporting the end panels are included in the end panel kit. Only the panels and those components needed to attach the end panels to an existing frame are included. Fasteners are designed for metal. If your end wall frame requires different fasteners, contact your sales representative to purchase additional fasteners, or purchase the proper fasteners locally.*

Important Information



YOU MUST READ THIS DOCUMENT BEFORE YOU INSTALL THE END PANEL POLYCARBONATE KIT.

Thank you for purchasing this ClearSpan™ Twin-Wall Polycarbonate Kit. When properly assembled and maintained, this product will provide years of reliable service. These instructions include helpful hints and important information needed to safely assemble and properly maintain the end panel kit. Please read these instructions **before** you begin.

If you have any questions during the assembly, contact Customer Service for assistance.

SAFETY PRECAUTIONS

- Wear eye protection.
- Wear head protection.
- Use a portable GFCI (Ground Fault Circuit Interrupter) when working with power tools and cords.
- Do not climb on the shelter or framing during or after construction.
- Do not occupy the shelter during high winds, tornadoes, or hurricanes.
- Provide adequate ventilation if the structure is enclosed.
- Do not store hazardous materials in the shelter.
- Provide proper ingress and egress to prevent entrapment.

⚠ WARNING: The individuals installing the end wall are responsible for designing and furnishing all temporary bracing, shoring and support needed during the assembly process.

For safety reasons, those who are not familiar with recognized construction methods and techniques must seek the help of a qualified contractor.

NOTE: Many ClearSpan™ shelters and greenhouses can be designed to meet the snow and wind load requirements in your area. Contact your account manager for additional information if needed.

REQUIRED TOOLS

The following list identifies the main tools needed to assemble the end wall. *Additional tools and supports may be needed depending on the structure, location, and application.*

- Tape measure or measuring device
- Fine point marker to mark the location on frame and panels
- Variable speed drill and impact driver (cordless with extra batteries works best)
- Metal file and metal-cutting saw
- Scissors or utility knife and tool to cut polycarbonate panels
- Hammers, gloves, and eye protection
- Ladders, work platforms, and other machinery for lifting designed to work safely at the height of the building and end wall.

ATTENTION: Consult the services of a qualified, professional contractor if you are not familiar with the construction of similar frame structures or the installation of comparable polycarbonate panels.

ATTACHING THE PANELS

When setting the panels in position, remember to install each panel with the UV-protected surface facing toward the outside. Read the information printed on each panel.

The diagrams in the Quick Start section show frames with installed sidewall panels. View these before attaching the panels to determine the best way to align the end panels with the sidewall panels if your building is equipped with sidewall panels.

Important Information

ASSEMBLY PROCEDURE

Following the instructions as presented will help ensure the proper installation of the polycarbonate panels. The steps outlining the assembly process are as follows:

1. Verify that all parts are included in the shipment. Notify Customer Service for questions or concerns.
2. Read these instructions and all additional documentation included with the shipment **before** you begin.
3. Gather the tools, bracing, ladders (and lifts), and assistants needed to assemble the end frame.
4. Check the weather **before** you install the end wall panels. *Do not install panels on a windy or stormy day or when such conditions are expected.*
5. Install the polycarbonate panels.
6. Read the care and maintenance information at the end of these instructions.
7. Complete and return all warranty information as instructed (if included).

UNPACK AND IDENTIFY PARTS

The following steps will ensure that you have all the necessary parts **before** you begin to install the end panels.

1. Unpack the contents of the shipment and place where you can easily inventory the parts. Refer to the Bill of Materials/Spec Sheets.
2. Verify that all parts listed on the Bill of Materials/Spec Sheets are present. If anything is missing or you have questions, consult the parts guide on the next page and all shelter diagrams for clarification, or contact customer service.

NOTE: At this time, you do not need to open the plastic bags containing smaller parts such as fasteners and clamps.

QUICK START GUIDE

For a quick overview of the end panel kit and its components, consult the Quick Start Guide located at the back of these instructions. Diagrams in the Quick Start section show frames with sidewall panels installed.

ATTACHING THE PANELS

When setting the panels in position, remember to install each panel with the UV-protected surface facing toward the outside. Read the information printed on each panel.

PARTS IDENTIFICATION

The following graphics and photos will help you identify the different hardware used for the installation of the end panel. (Some parts are not shown.)



102921B & FA4484B
Tek Screws and neobonded washers

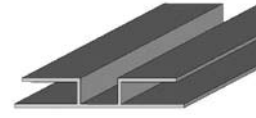

104212
Aluminum
H-Channel

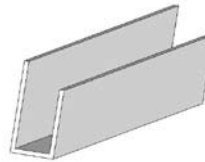

104213
Aluminum
U-Channel Profile



104774
Vent Tape



100441
Nut Setter

End Panel Installation

END PANEL INSTALLATION

The steps that follow describe one way to complete the polycarbonate panel installation. The materials and parts needed to install the polycarbonate panels include:

- Polycarbonate panels and vent tape (104774)
- Aluminum H-channel (#104212) and aluminum U-channel profile (#104213)
- Tek screws (#FA4484B) and neo-bonded, galvanized washers (#102921B)

Read the following information before starting:

- U-channel (104213) is used to finish the two (2) outside polycarbonate panel edges.
- H-channel (104212) is used to join polycarbonate panels at the seams between panels.
- Tek screws and neo-bonded washers are used to secure aluminum channel and panels to end wall frame.
- Install the polycarbonate panels with the UV-protected side to the outside. Mark this side with a piece of tape if needed *after* removing the protective film.

ATTENTION: Remove the protective film from the polycarbonate panels. *Do not stack panels in direct sunlight.* Allowing the film to remain intact and in direct sunlight will make the film difficult if not impossible to remove.

- During preparation, rest the edges of the panels on cardboard or other material to protect them from dirt and damage.
- **Do not install panels on a windy or stormy day or when such conditions are expected.**
- Consult the polycarbonate panels (Quick Start section) for the location and lengths of each panel. The diagrams are located at the back of these instructions.

ATTENTION: Position panels as shown on the panel diagrams. Using a panel in the incorrect place can affect the placement of subsequent panels. In addition, the amount of aluminum profile used between panels may not be adequate if additional seams are created.

Install all accessories (fans, vents, heaters, etc.) after installing all polycarbonate sheets.

If a door was purchased, review those instructions and position panels as needed to accommodate the door position and installation.

Install panel cells vertically to allow condensation to drain from the cells. Consult the polycarbonate panels diagrams located in the Quick Start section for panel locations and details for the 30' and 35' wide end walls. Complete the following steps to install the end panels.

1. Working from the center of the end wall, take one panel, remove the protective film, and mark the UV-protected side as a reminder to install this side toward the sun. **Check diagrams in the Quick Start section.**



Always remove the protective film, mark the surface with a piece of tape, and install the UV-protected side to the outside of the greenhouse.

2. Using the 104774 vent tape, tape the open cells as described below. **Cut panels to length before taping as instructed on the following pages.**

Apply tape to the lower end of all lower panels and to the upper end of all upper panels to seal the cell openings.

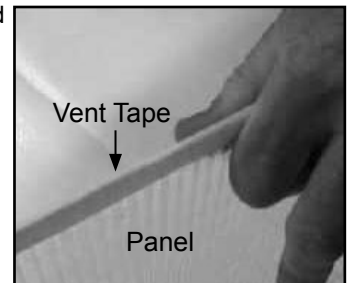

The two outer panels that span from ground level to the end rafter are taped at the top and bottom.

3. Take H-channel and attach to the outer edges of the panel and flush with the top and bottom of panel.

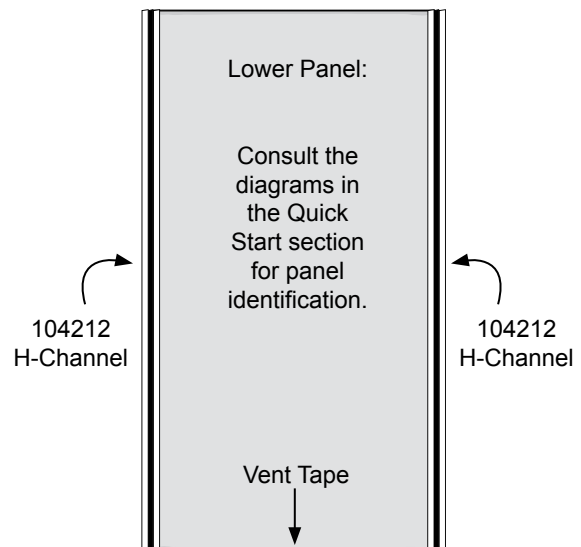

End Panel Installation

END PANEL INSTALLATION (continued)

- Locate and mark the center of the end wall and set the first prepared panel, *with the UV-protected side facing to the outside*, in position. Align the center of the H-channel with the center of the end frame.

ATTENTION: Consult the diagram in the Quick Start section for your end wall. *For the 30' wide frame*, trace the end cap profile location on the panel, remove the panel, and cut to fit. See lower-right diagram below.

- Verify that the panel is square on the frame in the desired position with the UV-protected surface toward the outside. Attach it to the end frame using Tek screws and washers (see photo to the right). **Install the Tek screws through the panel and into the brace every 12" on-center.** Do not overtighten screws!

NOTE: Install Tek screws in the channel of the aluminum H-channel. Do not use washers.

- With the panel attached to the end frame, repeat the steps to install the next panel. See diagrams on this page.

For the 30' wide frame, install all remaining panels and continue with Step 16. **For the 35' wide frame**, continue with Step 7.

Diagram below shows the 35' wide end wall. Actual end frame and panels may differ from frame shown. The installation of doors also will affect panel installation and position. Consult the panel diagrams located in the Quick Start section for the end kit ordered. **ATTENTION:** Installation of doors and other accessories in the end wall may result in leftover panel material and fasteners.

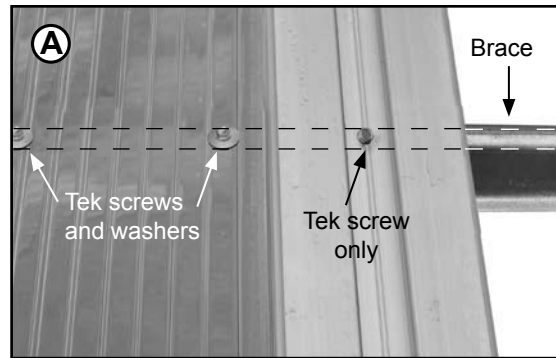

Use assistants when setting and securing the panels to the end frame.

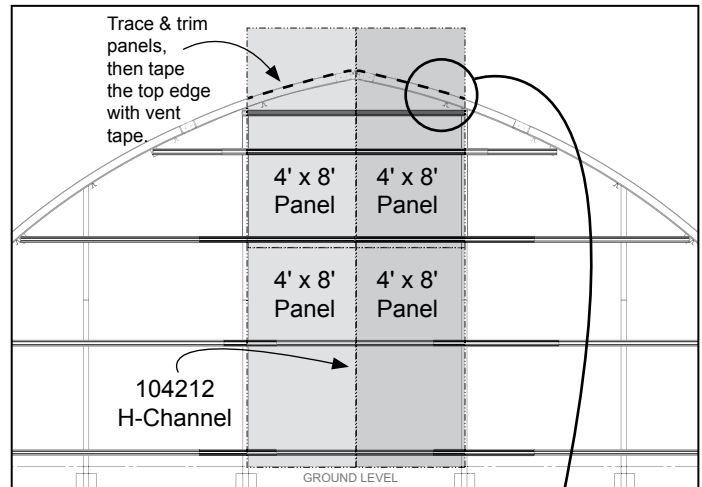

30' Wide End Wall

Trim H-channel as needed to fit under the lip of the end cap attached to the end rafter.

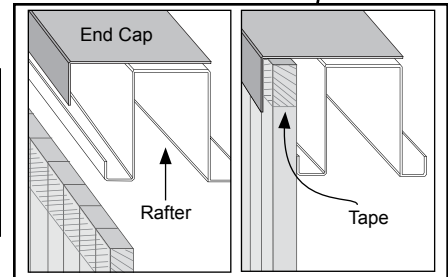

After trimming end panel to length, tape the top edge and slide panel under the lip of the end cap before securing to frame.

35' Wide End Wall

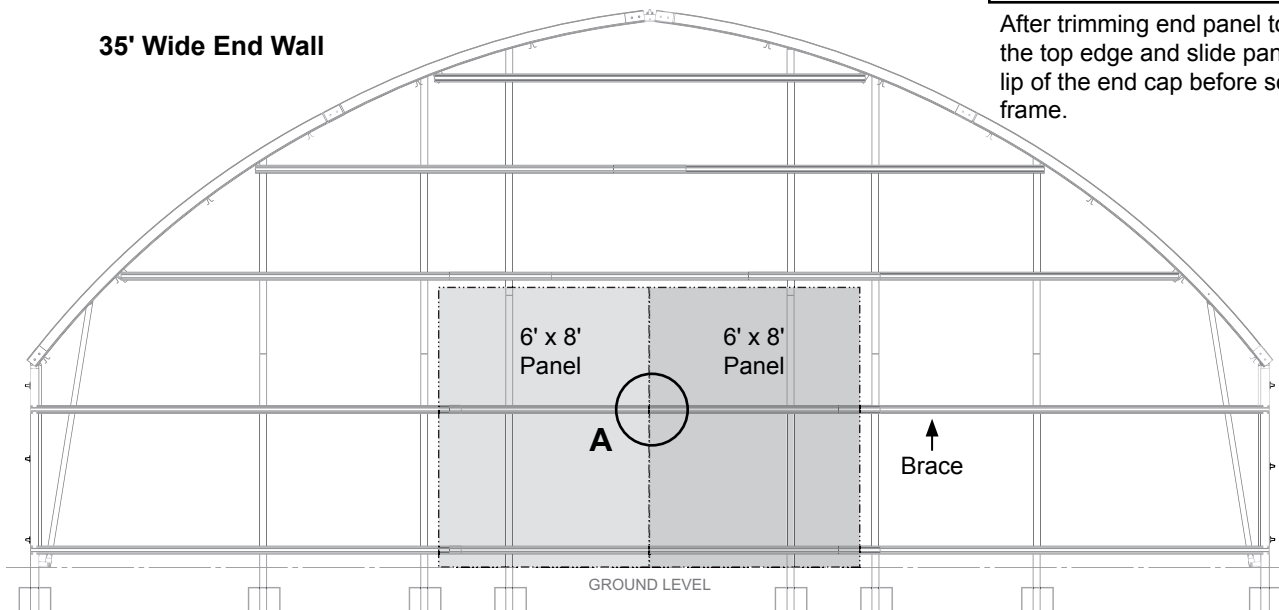

End Panel Installation

END PANEL INSTALLATION (continued)

7. Measure between the side H-channel sections of the center panel (or panels) and cut H-channel to length. See diagrams for panel size.
8. Install H-channel along the top of the installed lower panel (or panels). Upper panels slide into this H-channel (diagram B).
9. Set the first upper panel in place into the H-channel of the lower panel and align the edges with the lower panel. *Do not attach at this time.* Have an assistant hold the panel against the end frame. *Do not install panels on windy or stormy days.*
10. Using the end rafter end cap as a guide, trace along the end cap to mark the panel height. Set the panel on a protected surface and cut the panel to the correct size. **Cut the panel approximately 1/8" shorter to allow for easier installation.** Tape the cells at the upper end using vent tape.
11. Measure the distance along the vertical edges of the panel sides and cut H-channel to the measured length. *H-channel, when installed properly, is positioned under the end cap with the panel.* Use the end cap as a guide to properly cut the upper end of the H-channel.
12. Set the panel back in place, with the UV-protected side facing to the outside, against the end wall and install the H-channel along the edges. Top end of the side H-channel fits under the lip of the end cap and slides onto the polycarbonate panel.
13. Verify that the panel is square and in the desired position, and attach the panel to the end frame using Tek screws and washers.

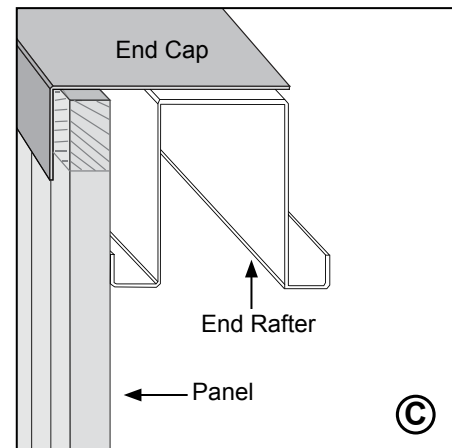
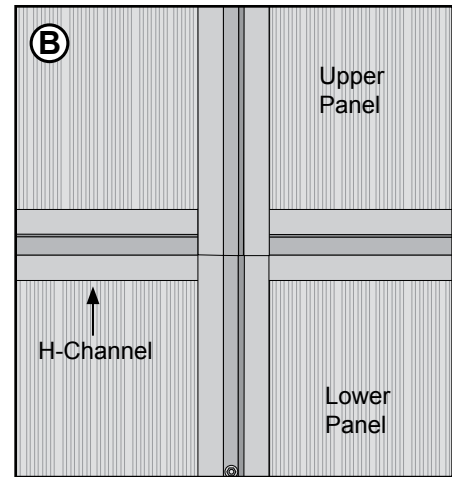

Trim H-channel as needed to fit under the lip of the end cap attached to the end rafter.

Install Tek screws and washers through the panel and into the end wall braces. Evenly space the screws at 12".

Actual end frame and panels may differ from frame shown. Consult the panel diagrams located in the Quick Start section for the end kit ordered.

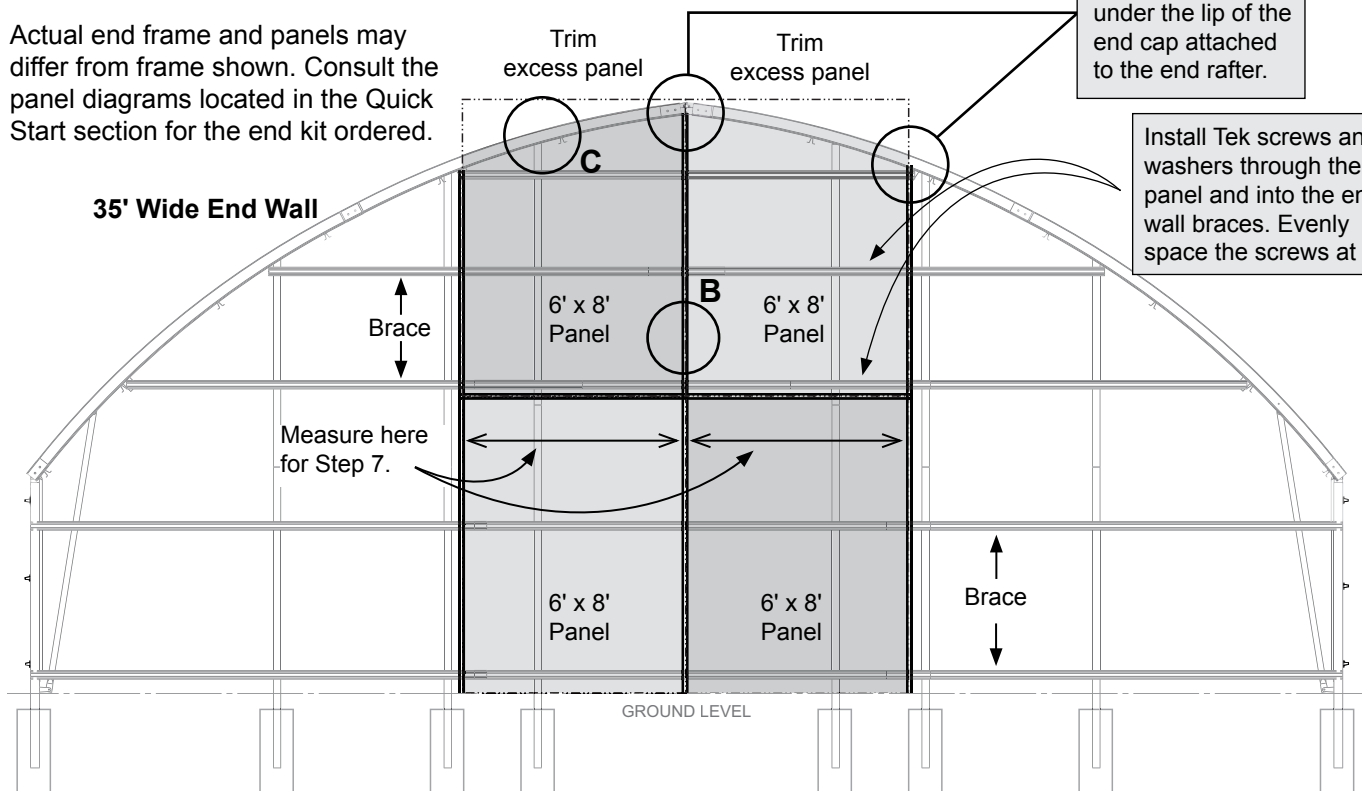

End Panel Installation

END PANEL INSTALLATION (continued)

14. Repeat steps to install the next panel. Work from the center outward to install the remaining panels.

35' wide: The center, upper panels include H-channel installed on both sides and along the bottom edge. The bottom H-channel is common between upper and lower panels and connects the two panels.

15. Finish the end wall using two (2) 6' x 10' panels on the outer position of the end wall. Measure, cut, and install panels as previously described. *Cut the outer 6' x 10' panels so each is flush with the side wall hat channel and installed side panels (if equipped) of the main building.*

NOTE: The edges of the two outer end panels must not extend beyond the edge of the side wall hat channel and installed sidewall panels. When installed, the panels of the end wall and sidewall meet to form a finished edge at each corner of the building.

16. Measure and cut a section of 104213 profile and install it along the outside edge of each outer panel to complete installation (see drawing C).

17. Install a Tek screw to secure the H-channel to the frame in each place where H-channel crosses the end wall brace. See letter D in the diagram below for an example.

18. Continue by reading the care and maintenance section.

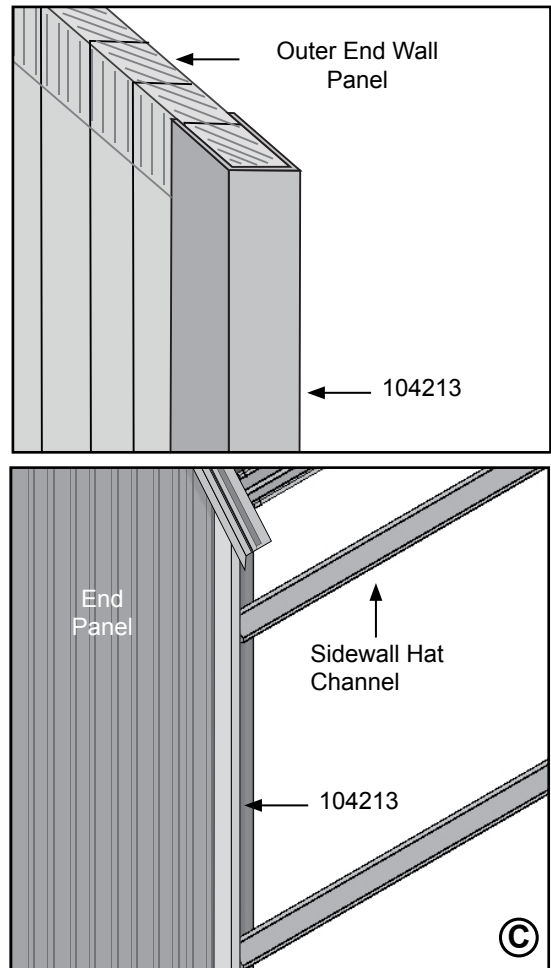

35' Wide End Wall

Panel pattern may vary. Refer to the panel diagrams located in the Quick Start section for the layout of panels for your end wall.

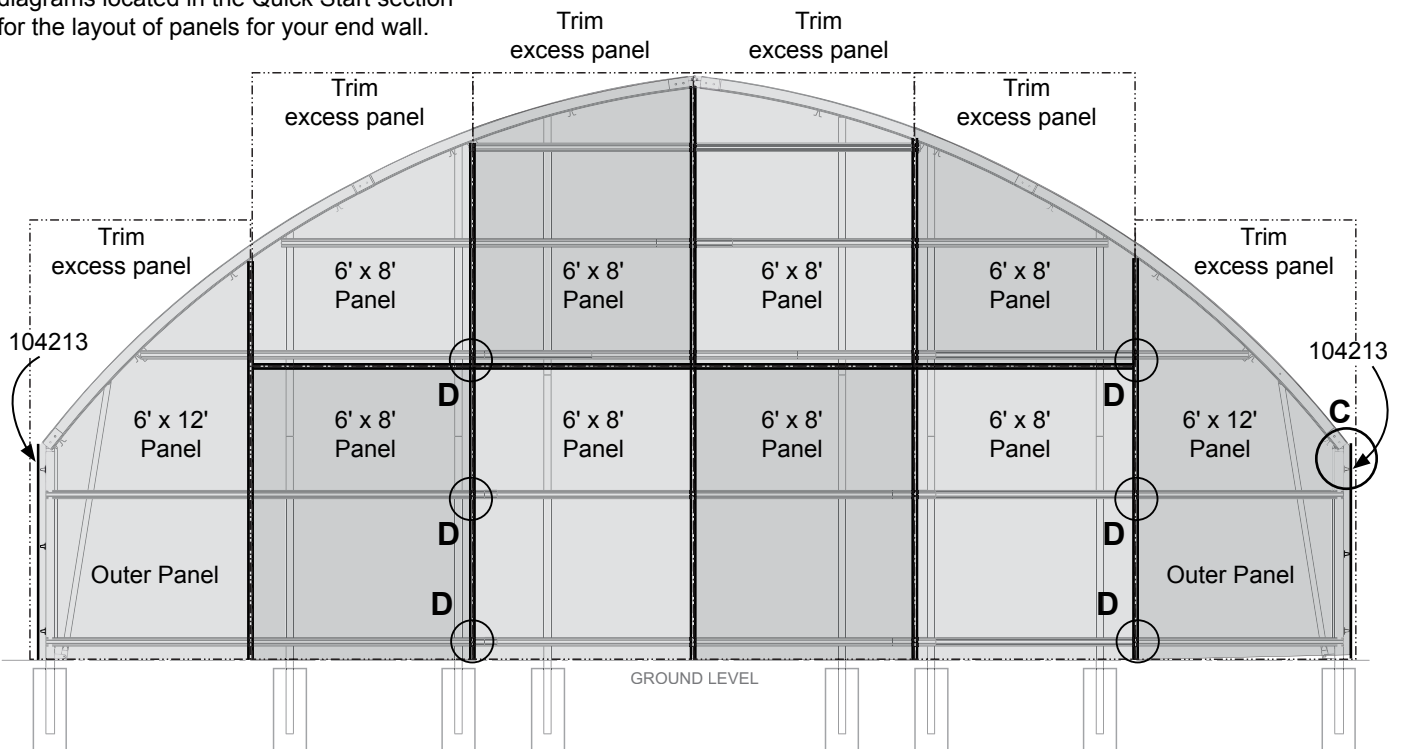

Shelter Care and Maintenance

SHELTER CARE AND MAINTENANCE

Proper care and maintenance of the end panels is important. Check the following items periodically to properly maintain the end panels:

- Regularly check the polycarbonate panels to see that these are secure and in good condition. Replace damaged panels if needed.
- Check connections and all fasteners to verify that they remain tight.
- Check the contents of the shelter to verify that nothing is touching the polycarbonate panels that could cause damage.
- Inspect the end wall frequently and regularly to ensure that it remains secure and in good repair.
- Replace broken or missing components immediately.
- If the shelter is moved, inspect all parts and connections before it is reassembled.
- For replacement or missing parts, call your sales associate for assistance.



Space below is reserved for customer notes.

Quick Start Guide



QUICK START GUIDE

30' and 35' Wide End Panels

IMPORTANT: Diagrams throughout this manual show the end panels installed in line with the outside edge of the end rafter legs or ground posts (no sidewall panels).

For buildings that include sidewall polycarbonate panels, shift the position of the end panels as needed so these panels meet the sidewall panels and create a finished corner. Diagrams in this section include sidewalls.

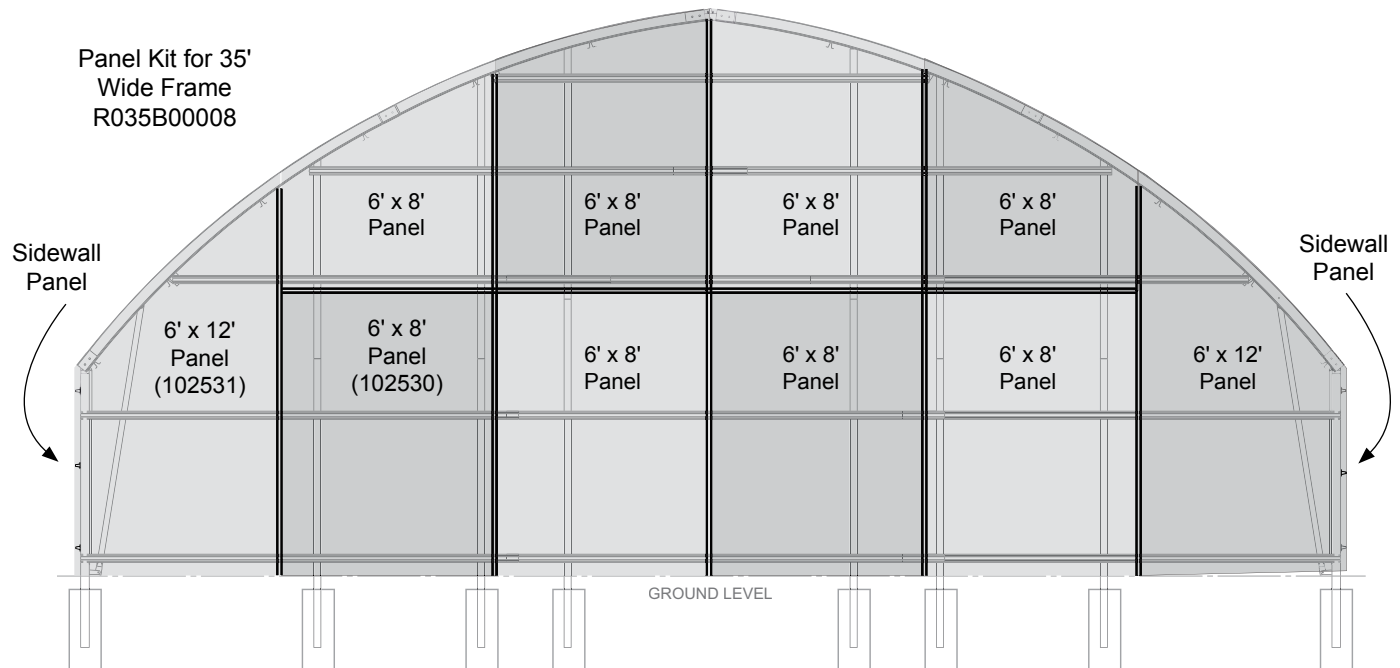
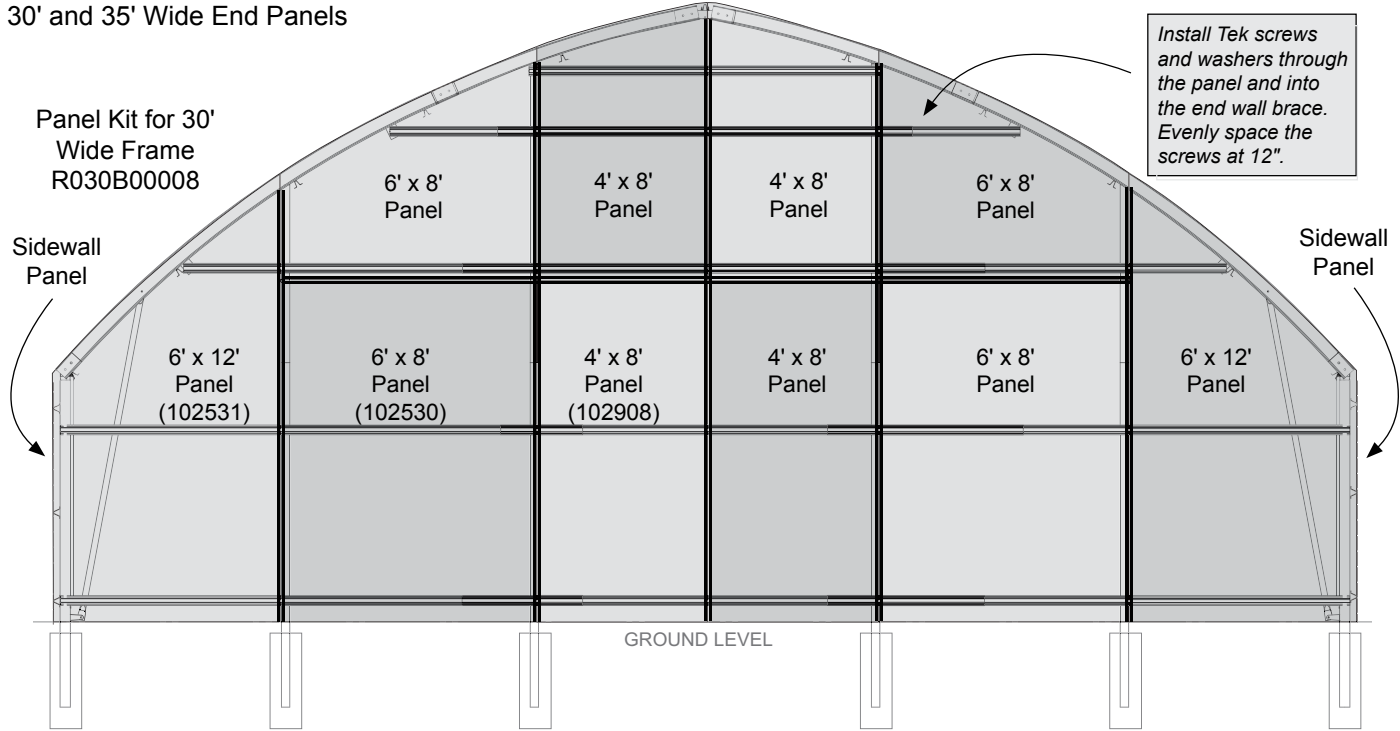

Polycarbonate Panels - 30' Wide

If a door was purchased, position panels as needed to accommodate the door installation. Install door frames before end panels. Install the end panels before the sliding door installation.

Diagram below shows the installed sidewall hat channel used for the installation of the sidewall polycarbonate panels of the main building.

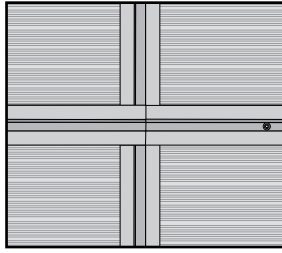

Trim H-channel as needed to fit under the lip of the end cap attached to the end rafter.

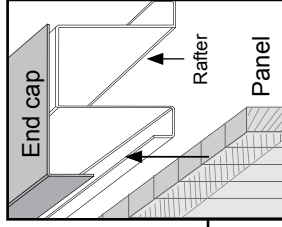

SIDE VIEW

NOTE: Install vent tape on the bottom edges of the lower panels and along the top edges of the upper panels after these are cut to fit. Tape the top and bottom of the outer panels (marked with an X).

Remember to position and trim the outer panel so it meets the sidewall panels if sidewall panels are installed. Some buildings may not include sidewall panels.

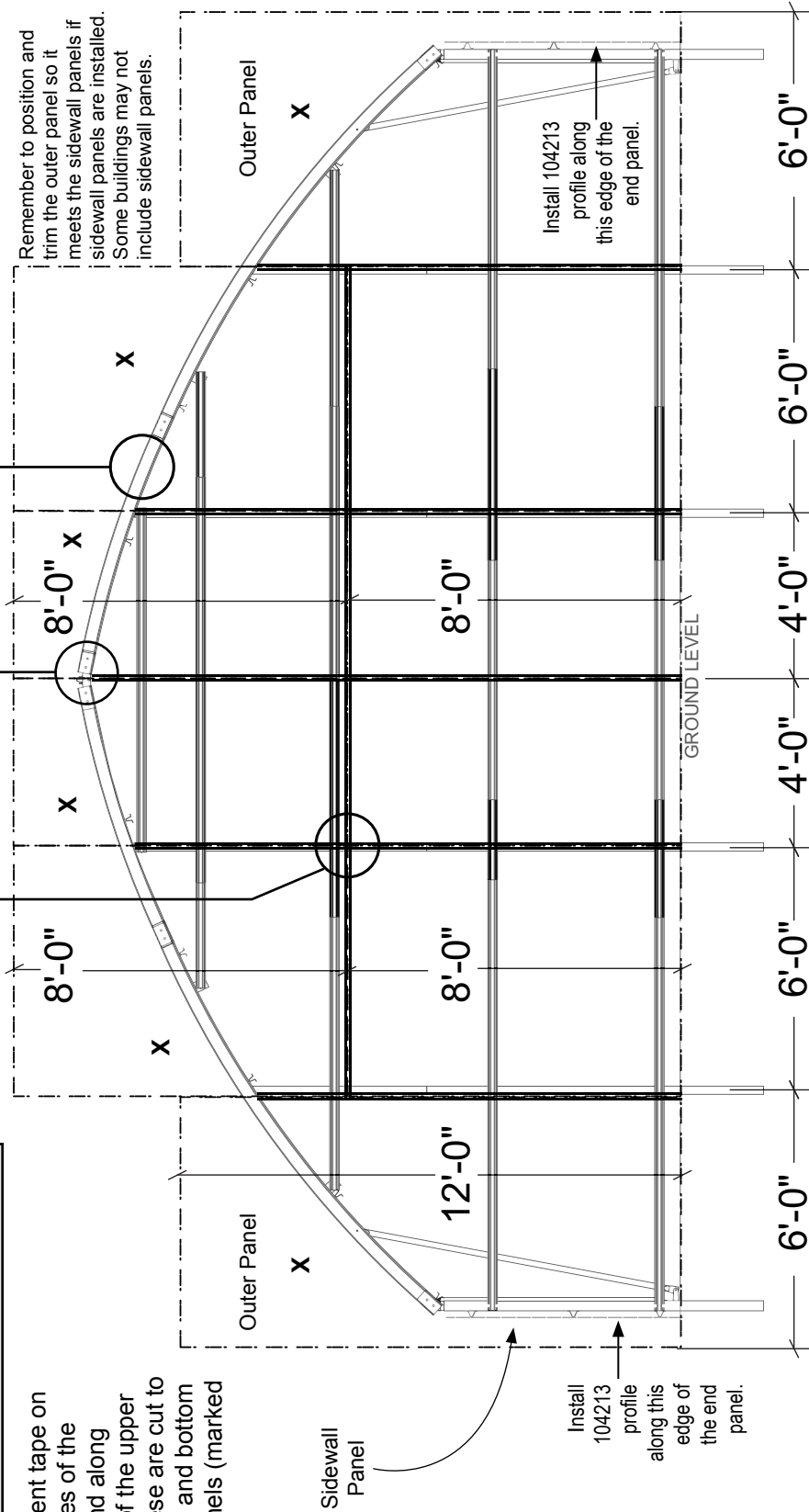

All polycarbonate panels to be installed with UV-protected surface toward the outside of the shelter.

Symbol Key

104212 Alum H-Channel

104213 Alum U-Channel

Polycarbonate Panels - 35' Wide

If a door was purchased, position panels as needed to accommodate the door installation. Install door frames before end panels. Install the end panels before the sliding door installation.

Diagram below shows the installed sidewall hat channel used for the installation of the sidewall polycarbonate panels of the main building.

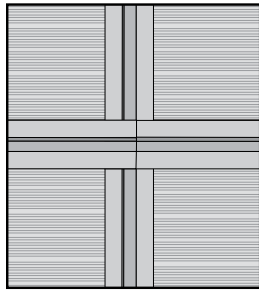

Trim H-channel as needed to fit under the lip of the end cap attached to the end rafter.

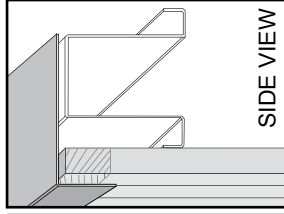
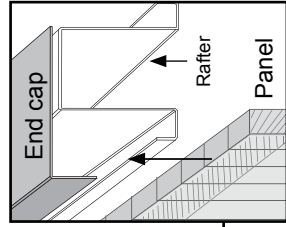

NOTE: Install vent tape on the bottom edges of the lower panels and along the top edges of the upper panels after these are cut to fit. Tape the top and bottom of the outer panels (marked with an X).

Remember to position and trim the outer panel so it meets the sidewall panels if sidewall panels are installed. Some buildings may not include sidewall panels.

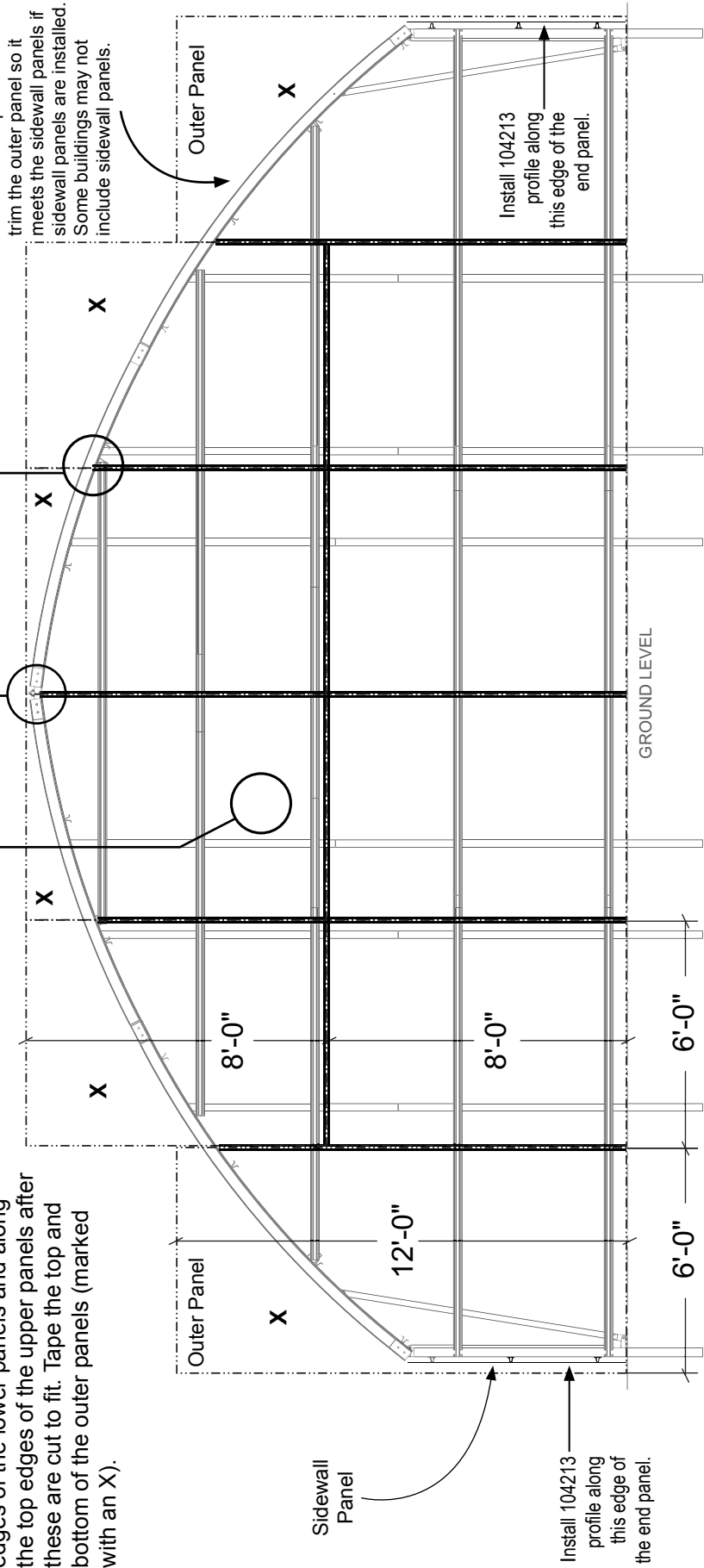

Symbol Key
 104212 Alum H-Channel
 104213 Alum U-Channel

All polycarbonate panels to be installed with UV-protected surface toward the outside of the shelter.

Notes



This page is reserved for customer notes.