

FarmTek®

Equipment Canopies



Photo may show a different but similar model.

©2008 FarmTek®
All Rights Reserved. Reproduction
is prohibited without permission.



WARNING: Cancer and Reproductive Toxicity - P65Warnings.ca.gov

STK#	DIMENSIONS
104321	6' W x 10' L
104322	6' W x 20' L
104323	6' W x 30' L

Revision date: 07.21.08

FarmTek®

YOU MUST READ THIS DOCUMENT BEFORE YOU BEGIN TO ASSEMBLE THE SHELTER.

Thank you for purchasing this FarmTek® shelter. When properly assembled and maintained, this product will provide years of reliable service. These instructions include helpful hints and important information needed to safely assemble and properly maintain the shelter. Please read these instructions **before** you begin.

If you have any questions during the assembly, contact Customer Service for assistance.

SAFETY PRECAUTIONS

- Wear eye protection.
- Wear head protection.
- Wear gloves when handling metal tubes.
- Use a portable GFCI (Ground Fault Circuit Interrupter) when working with power tools and cords.
- Do not climb on the shelter or framing during or after construction.
- Do not occupy the shelter during high winds, tornadoes, or hurricanes.
- Provide adequate ventilation if the structure is enclosed.
- Do not store hazardous materials in the shelter.
- Provide proper ingress and egress to prevent entrapment.

ANCHORING INSTRUCTIONS

Prior to assembling this shelter, please read the **MUST READ** document included with the shipment.

⚠ WARNING: The anchor assembly is an integral part of the shelter construction. Improper anchoring may cause shelter instability and failure of the structure to perform as designed. Failing to anchor the shelter properly *will void the manufacturer's warranty* and may cause serious injury and damage.

LOCATION

Choosing the proper location is an important step before you begin to assemble the structure.

The following suggestions and precautions will help you determine whether your selected location is the best location.

- Never erect the structure under power lines.
- Identify whether underground cables and pipes are present *before* preparing the site or anchoring the structure.
- Location should be away from structures that could cause snow to drift on or around the shelter.
- Do not position the shelter where large loads such as snow and ice, large tree branches, or other overhead obstacles could fall.

SITE

After choosing a location, proper preparation of the site is essential. Follow the information below helps to ensure the integrity of the structure.

- *A level site is required.* The site must be level to properly and safely erect and anchor the structure.
- For sites that are not concrete or gravel, placing wood blocks or other suitable supports under each rafter leg helps prevent the pipes from sinking or working into the site. Does not apply to shelters with ground posts.
- Drainage: Water draining off the structure and from areas surrounding the site should drain away from the site to prevent damage to the site, the structure, and contents of the structure.

⚠ WARNING: The individuals assembling this structure are responsible for designing and furnishing all temporary bracing, shoring and support needed during the assembly process. For safety reasons, those who are not familiar with recognized construction methods and techniques must seek the help of a qualified contractor.

ASSEMBLY PROCEDURE

Following the instructions as presented will help ensure the proper assembly of your shelter. Failing to follow these steps may result in an improperly assembled and anchored shelter and will void all warranty and protection the owner is entitled to.

The steps outlining the assembly process are as follows:

1. Verify that all parts are included in the shipment. Notify Customer Service for questions or concerns.
2. Read these instructions, the Must Read document, and all additional documentation included with the shipment **before** you begin assembling the shelter.
3. Gather the tools, bracing, ladders (and lifts), and assistance needed to assemble the shelter.
4. Check the weather **before** you install the roof cover and any panels (if equipped). Do not install covers or panels on a windy or stormy day.
5. Re-evaluate the location and site based on the information and precautions presented in the documentation included with the shipment.
6. Lay out the site (if this has not been completed).
7. Assemble the frame components in the order they are presented in these instructions.
8. Assemble the frame including the struts (if equipped).
9. Consult the MUST READ document and properly anchor the assembled frame.
10. Install, tighten, and secure the main cover and panels (if equipped). This applies to fabric covers that stretch over the frame assembly. Your shelter may include roof panels or side panels or both.
11. Read the care and maintenance information at the end of these instructions.
12. Complete and return all warranty information as instructed.

LIST OF WORDS AND PHRASES

Before you begin, it is important to become familiar with the words and phrases used in this instruction manual.

These words and phrases are common to most FarmTek® shelters and identify the different parts of the shelter. (Some are used in this document. Others may not apply to this particular shelter.) These terms describe the shipped parts and can also be found on the materials list/spec sheets included with the shipment. To aid in the assembly, read through the following definitions before you begin to assemble your shelter.

- **Conduit:** An assembly of pipes used to secure the main cover and end panels (if equipped). Purlins and some strut assemblies also consist of connected pipes to form a conduit. Each pipe joint of a conduit assembly is secured with a self-tapping Tek screw.
- **Coupler or Fitting:** A part of the frame assembly where legs, purlins and rafter pipes are inserted and secured. In most instances, 3-Way and 4-Way couplers are used. In some larger applications, couplers are used to secure the joints of the different rafter sections during the assembly of the rafters. Some shelters do not use couplers.
- **Foot or Rafter Foot:** The part attached to and found at the base of the rafter or leg of the shelter. Depending on the shelter, the foot is an optional purchase. Some shelters do not offer an optional foot. Some use 1-way connectors; others use ground posts.
- **Must Read Document:** This document includes building and shelter anchoring instructions, steps for end wall reinforcement, safety precautions, and notices and warnings. The Must Read document is sent with all shelters and buildings. If you did not receive a Must Read document, contact Customer Service to request one.
- **On-Center:** Term used to describe a measurement taken from the vertical center of the rafter or frame member to the vertical center of another.
- **Purlin:** The pipe assembly that runs perpendicular to the rafters or framework that supports the main cover. Purlins are found on the sides and roof areas of the assembled frame, are evenly spaced, and typically run from the front to the back of the shelter.
- **Plain or Straight Pipe:** A term used to describe a pipe that has the same diameter or width throughout its entire length.
- **Strut:** A strut is usually a length of pipe with two flattened ends and is used for diagonal bracing of the shelter frame. A strut is typically secured to the frame work by special brackets and bolts.
- **Swaged End or Swaged Pipe:** The term “swaged” refers to the tapered end of the pipe or tube. Swaged ends of a pipe can be inserted into couplers and the straight ends of other pipes.
- **Tek screw:** A self-tapping fastener used to secure pipe joints and to fasten brackets to rafters.

WEATHERSHIELD CANOPIES

REQUIRED TOOLS

The following list identifies the main tools needed to assemble the shelter. Additional tools and supports may be needed depending on the structure, location, and application.

- Tape measure or measuring device
- Hammers and gloves
- Ladders, work platforms, and other machinery for lifting designed to work safely at the height of the shelter.

UNPACK AND IDENTIFY PARTS

The following steps will ensure that you have all the necessary parts *before* you begin to assemble the shelter.

1. Unpack the contents of the shipment and place where you can easily inventory the parts. Refer to the Bill of Materials/Spec Sheets.
2. Verify that all parts listed on the Bill of Materials/Spec Sheets are present. If anything is missing or you have questions, consult the Pictorial Parts Guide and all shelter diagrams for clarification, or contact Customer Service at 1-800-245-9881.

NOTE: At this time, you do not need to open the plastic bags containing smaller parts such as fasteners or washers.

QUICK START DIAGRAMS

For a quick overview of the shelter and its components, consult the Quick Start diagrams at the back of these instructions.

Continue with **FRAME ASSEMBLY** procedures that follow.

ALTERNATIVE ASSEMBLY INFORMATION

These instructions describe assembling the entire roof section of the shelter first. The frame is then lifted and the legs added. For long shelters or when limited assistance is available, constructing the frame and legs in sections suitable for lifting and moving and working from one end to the other is an alternative assembly method. (This method is not shown.)

To assembly the frame in sections, read these instructions first and adapt the steps as needed. Consult all diagrams and the Quick Start section of this manual to better understand how the frame is assembled before you begin. Install the main cover as a single unit after the frame is assembled and anchored.

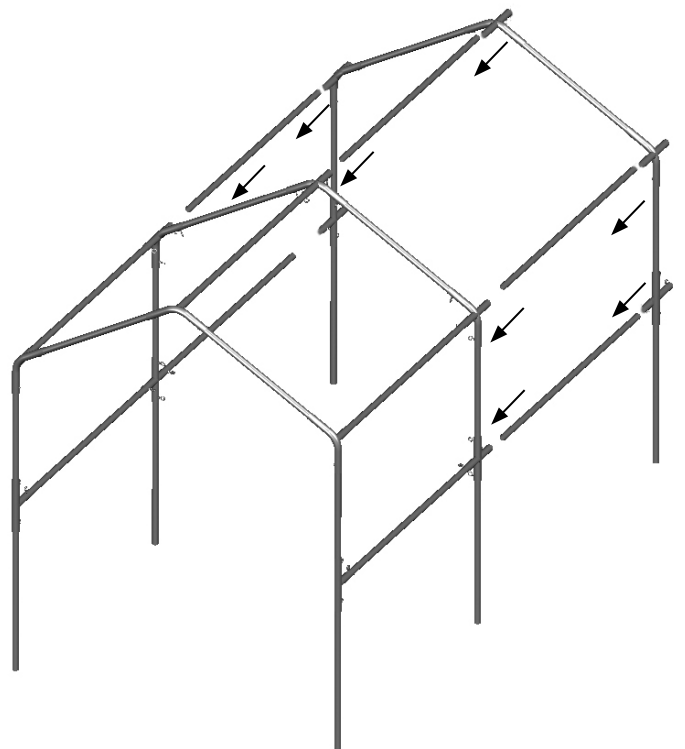

FarmTek®

The following graphics and photos will help you identify the different parts and show you how they are used. (Not all parts are shown.)

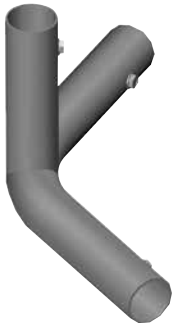

102191
3-Way Coupler

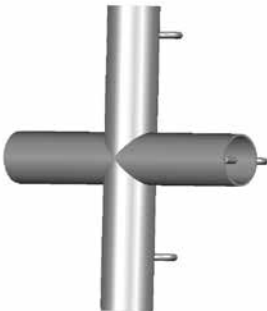

104651
Cross Coupler

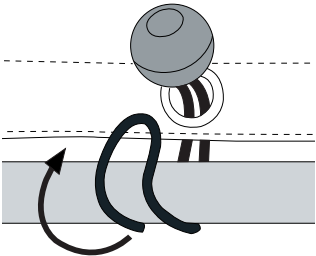

CC4595
Tie Down 8" Snugger Ball

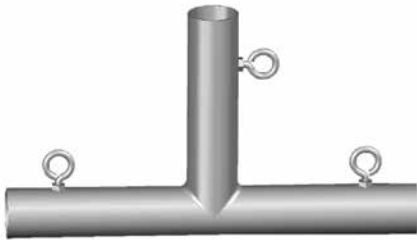

102205
Tee Coupler

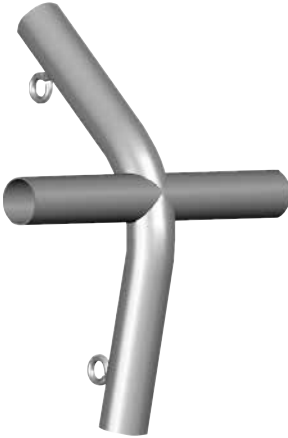

102192
4-Way Coupler

WEATHERSHIELD CANOPIES

ADDITIONAL PARTS IDENTIFICATION NOTES

In some instances, there can be differences between the parts that are shown and referenced in the instructions and the parts that are shipped with the shelter. These differences *do not* affect the integrity of the shelter, but can change the assembly procedures.

The information that follows identifies possible changes in the assembly procedure found in this instruction document. *Please implement these changes during the assembly of the shelter.*

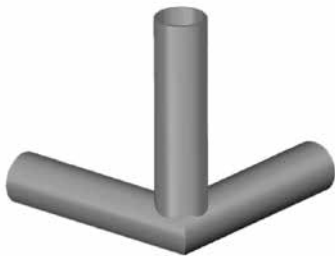

3-Way Coupler (no lock bolt)

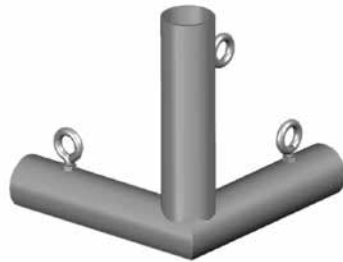

3-Way Coupler (includes lock bolt)

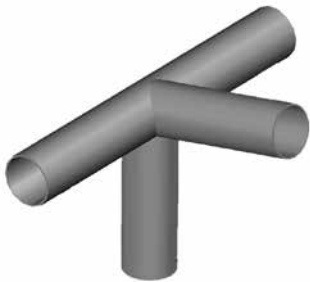

4-Way Coupler (no lock bolt)

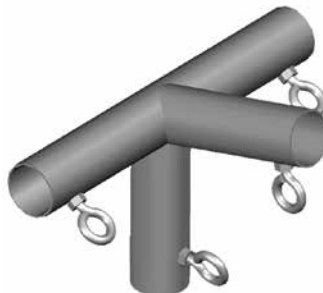

4-Way Coupler (includes lock bolt)

There can be two types of couplers used during the assembly of the shelter: those that include an installed locking eyebolt and those that do not. See above.

If the couplers included with your shelter do not have an installed lock bolt, use a *self-tapping Tek screw* to secure the different pipes to the couplers during the assembly process. The self-tapping Tek screws are included with the shipment.

ATTENTION: Tek screws are sent with all shelters of this type. For couplers with locking eyebolts, install the Tek screws at each pipe connection for additional security if desired.

⚠ WARNING: To prevent personal injury and damage to the shelter, *fasten and tighten a Tek screw* at each pipe and coupler joint.

To prevent cover damage, install the Tek screw so that it *does not* touch the main cover or any optional side or end panels once these are installed.

WeatherShield Canopies



ASSEMBLE THE MAIN ROOF FRAME (ALL LENGTHS)

This section is an overview of the process for assembling your roof frame. See illustration below to identify main parts of the frame. Consult Quick Start section for details.

1. Locate the required couplers, rafter pipes, and purlin pipes to assemble the roof frame as shown below.
2. Secure each pipe in the coupler using the locking eyebolt. If the couplers are not equipped with locking eyebolts, secure each pipe in the coupler using a Tek screw.

NOTE: Diagrams show where to install Tek screws if the couplers are not equipped with locking eyebolts.

ATTENTION: Position Tek screws so they *will not* touch the main cover when installed.

All locking eyebolts of the couplers must be installed to the inside of the shelter.

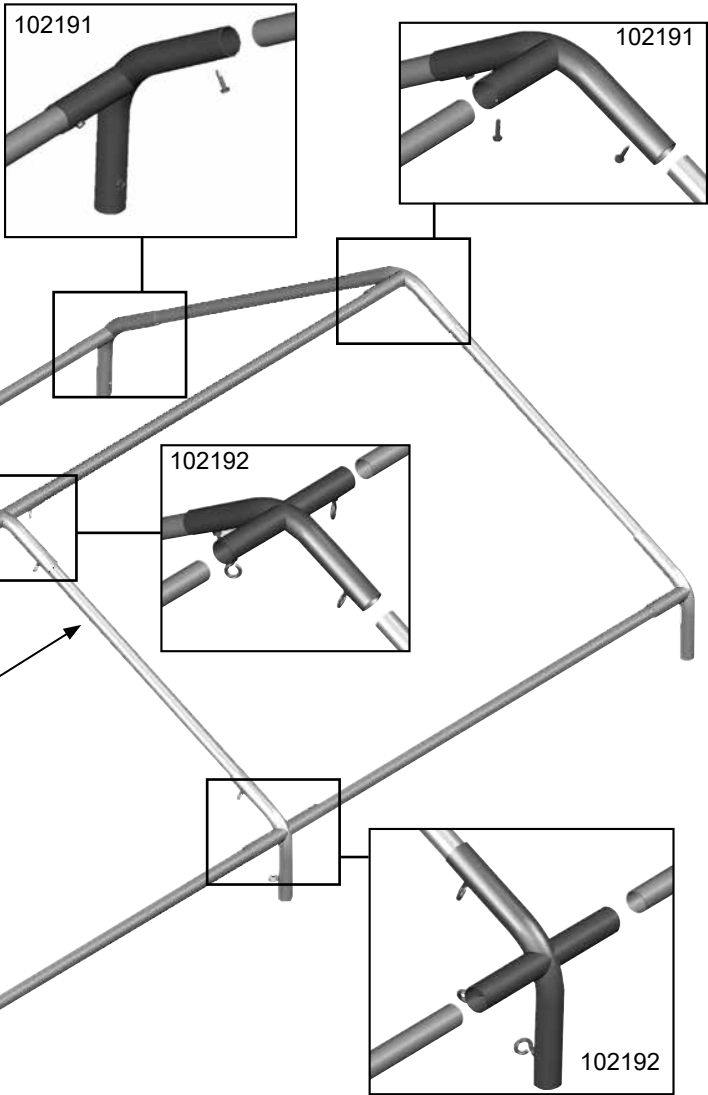

Purlins

Rafters

Pipe Identification		
Location	Pipe	Length
Rafter	131P03675	36.75"
Purlin	131P058	58"

Frame length shown may differ from actual frame.

WEATHERSHIELD CANOPIES

INSTALL LOWER PURLINS AND LEGS

This section is an overview of the process for attaching the lower purlins and legs to the roof frame. See illustration below to identify main parts of the frame.

- Using the upper leg pipes, insert the legs into the 3-way and 4-way couplers of the main frame. *Do not install the main frame legs during a storm or windy day.*
 - Secure each pipe in the coupler using the locking eyebolt. If the couplers are not equipped with locking eyebolts, secure each pipe in the coupler using a Tek screw.
- ATTENTION:** Position Tek screws so they *will not* touch the main cover when installed.
- Locate the required couplers, lower leg pipes and purlin pipes to assemble the lower frame and attach to the frame as shown below.
 - Inspect the frame for sharp edges or Tek screws that could damage the covers. Reinstall the Tek screws if necessary (or rotate the pipes) and remove or tape any sharp edges.

- After the entire frame is assembled, verify that each locking eyebolt is tight.
 - Set the frame in the desired location and measure diagonally from corner-to-corner to square the frame. The diagonal measurements will be identical when the frame is square. *Verify width between leg pipes.*
 - Properly anchor the assembled frame as described in the MUST READ document included with the shipment.
- NOTE:** DO NOT install the cover without anchoring the frame.
- After anchoring the frame, continue with attaching the main cover.

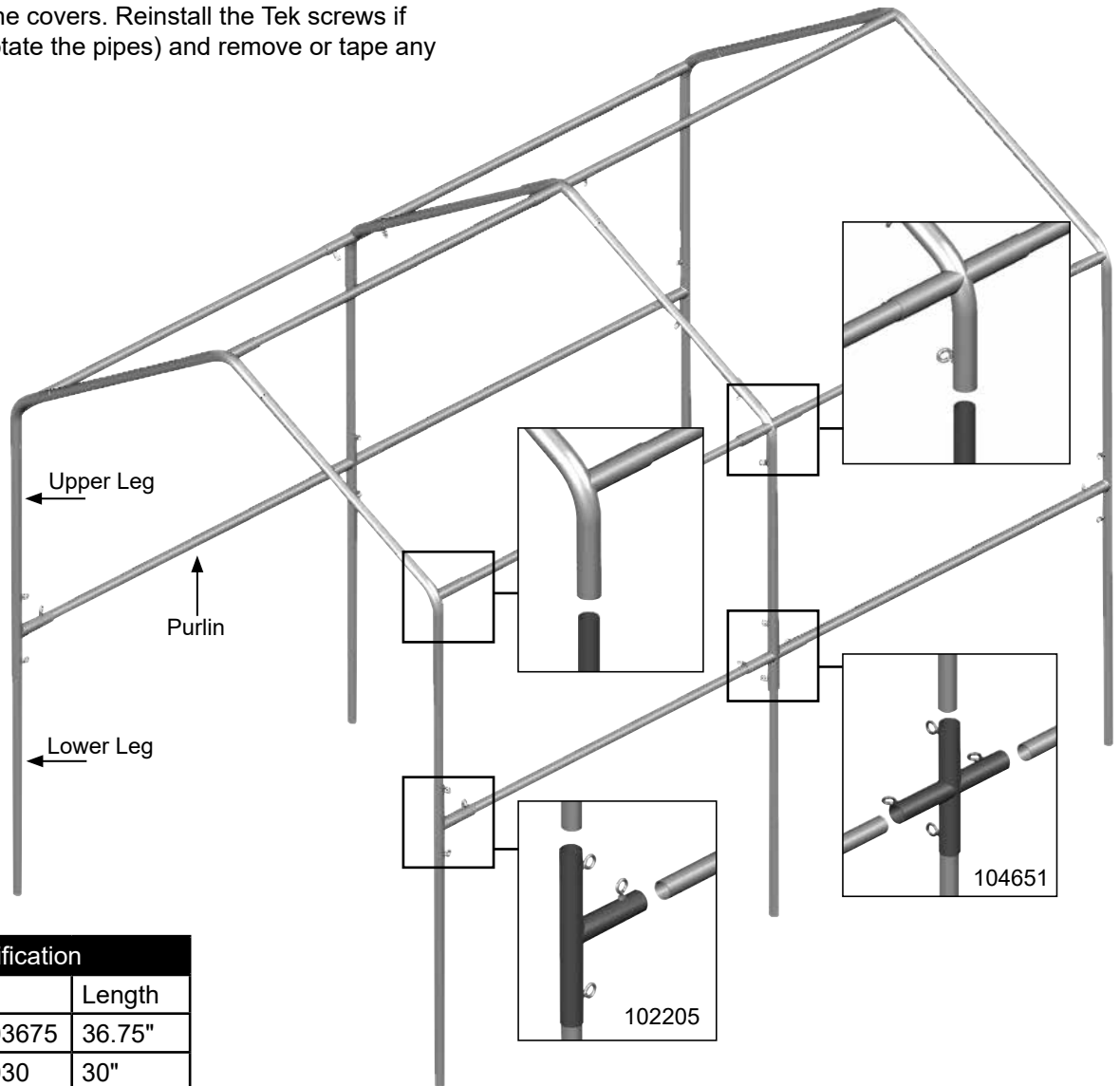

Pipe Identification		
Location	Pipe	Length
Lower Leg	131P03675	36.75"
Upper Leg	131P030	30"
Purlin	131P058	58"

NOTE: Frame length shown may differ from actual frame.

INSTALL THE MAIN FRAME COVER

After the frame is properly squared and anchored, install the main cover.

Gather the parts:

- Snugger ball tie downs (#CC4595)
- Main cover

NOTE: Assistance is required to install the main cover.

⚠ WARNING: To prevent property damage and personal injury, do not install the cover on a windy or stormy day.

NOTE: Dashed lines show where to attach the main cover to the frame. The main cover *will not* wrap around the frame piping.

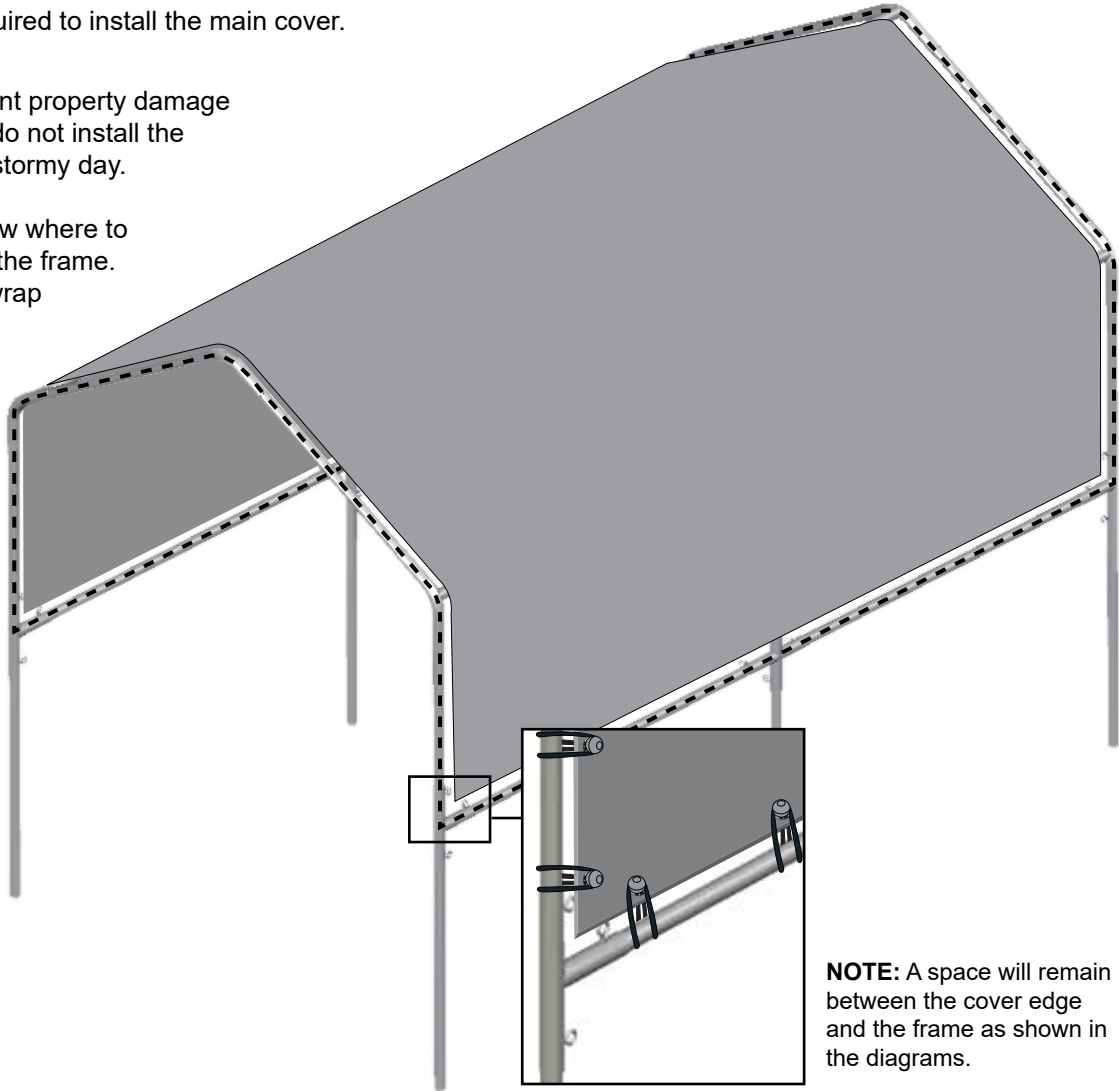

1. Locate the main cover, unfold it along the assembled frame, and drape it over the frame and into position.
2. Take the snugger ball tie downs, feed the stretch cord through a grommet, and attach the main cover to the assembled frame. Use one snugger ball for each grommet.
3. Continue with the shelter care and maintenance information that follows.

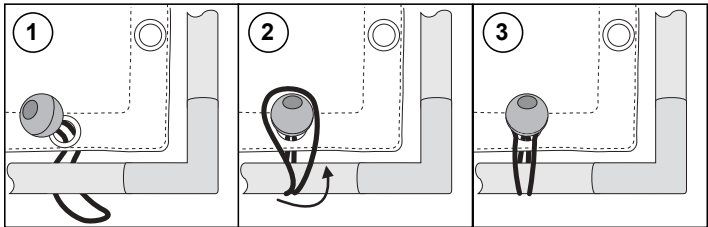

WEATHERSHIELD CANOPIES

CARE AND MAINTENANCE

Proper care and maintenance of the shelter will help to ensure years of service. The following items identify areas that should be periodically checked to ensure that your shelter is maintained properly:



Space below is reserved for customer notes.

- Regularly check the roof covers to see that they remain tight and in proper repair.
- Check connections and all fasteners to verify that they remain tight.
- Do not climb or stand on the shelter at anytime.
- Remove debris and objects that can accumulate on the shelter. Use tools that will not damage the cover when removing debris.
- Remove snow to prevent excess accumulation. Use tools that will not damage the cover when removing snow.
- Check the contents of the shelter to verify that nothing is touching the cover that could cause damage.
- Check the anchoring system to ensure that all components are tight and in good repair.
- If the shelter is moved, inspect all parts and connections before reassembling.
- Never pack the covers when they are wet. Always dry them before you pack the shelter.
- For replacement or missing parts, call 1-800-245-9881 for assistance.

NOTE: With the exception of Truss Arch buildings, FarmTek® shelters and greenhouses *do not* have any tested loading criteria.

FarmTek®

QUICK START GUIDE

6' Wide Equipment Canopies



104321 (6' X 10')

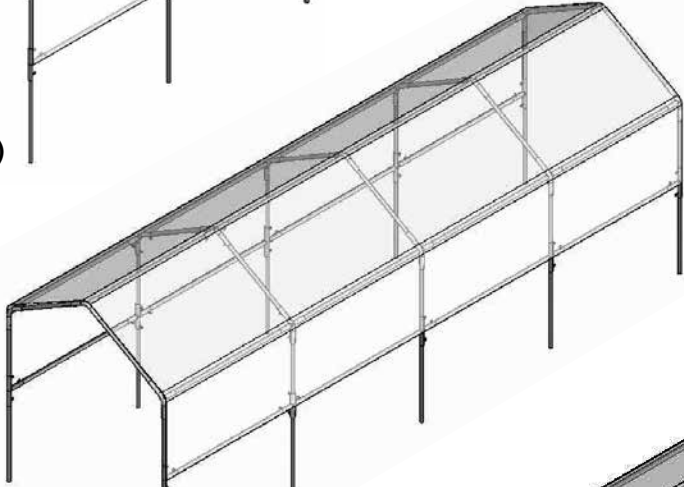

104322 (6' X 20')

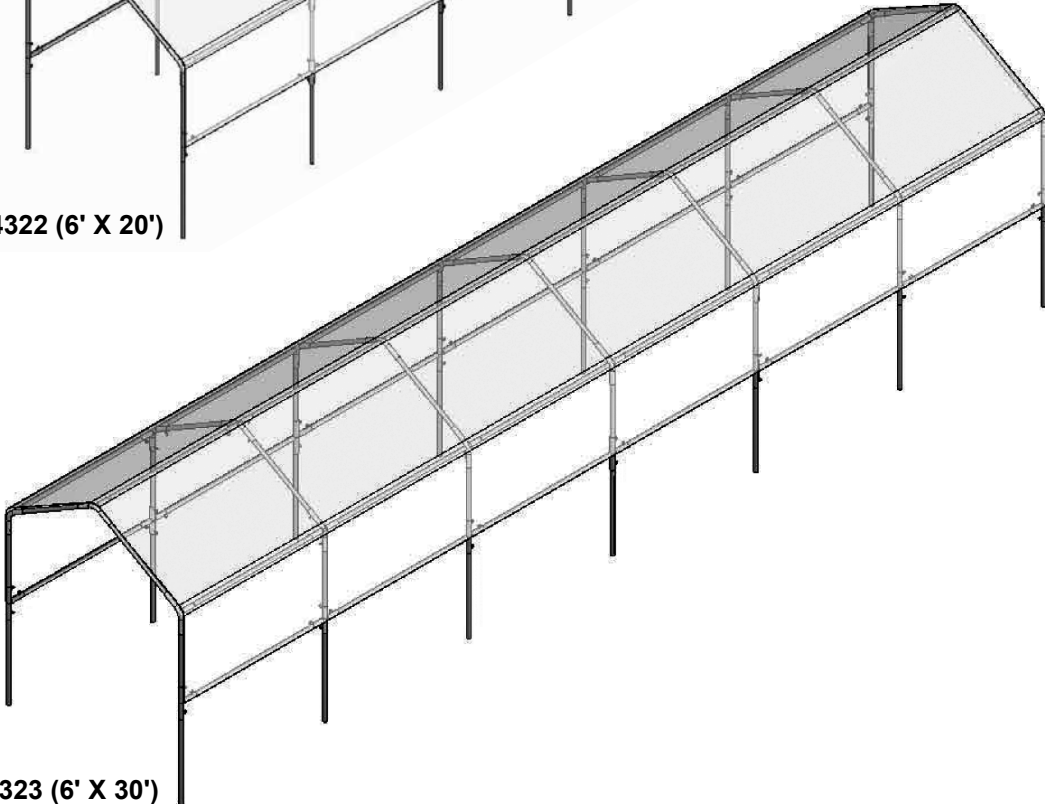

104323 (6' X 30')

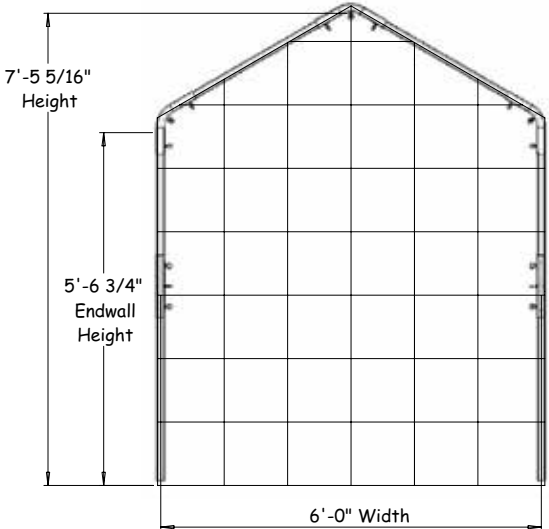

FRONT
Grid Represents 12" Squares

FRONT PROFILE

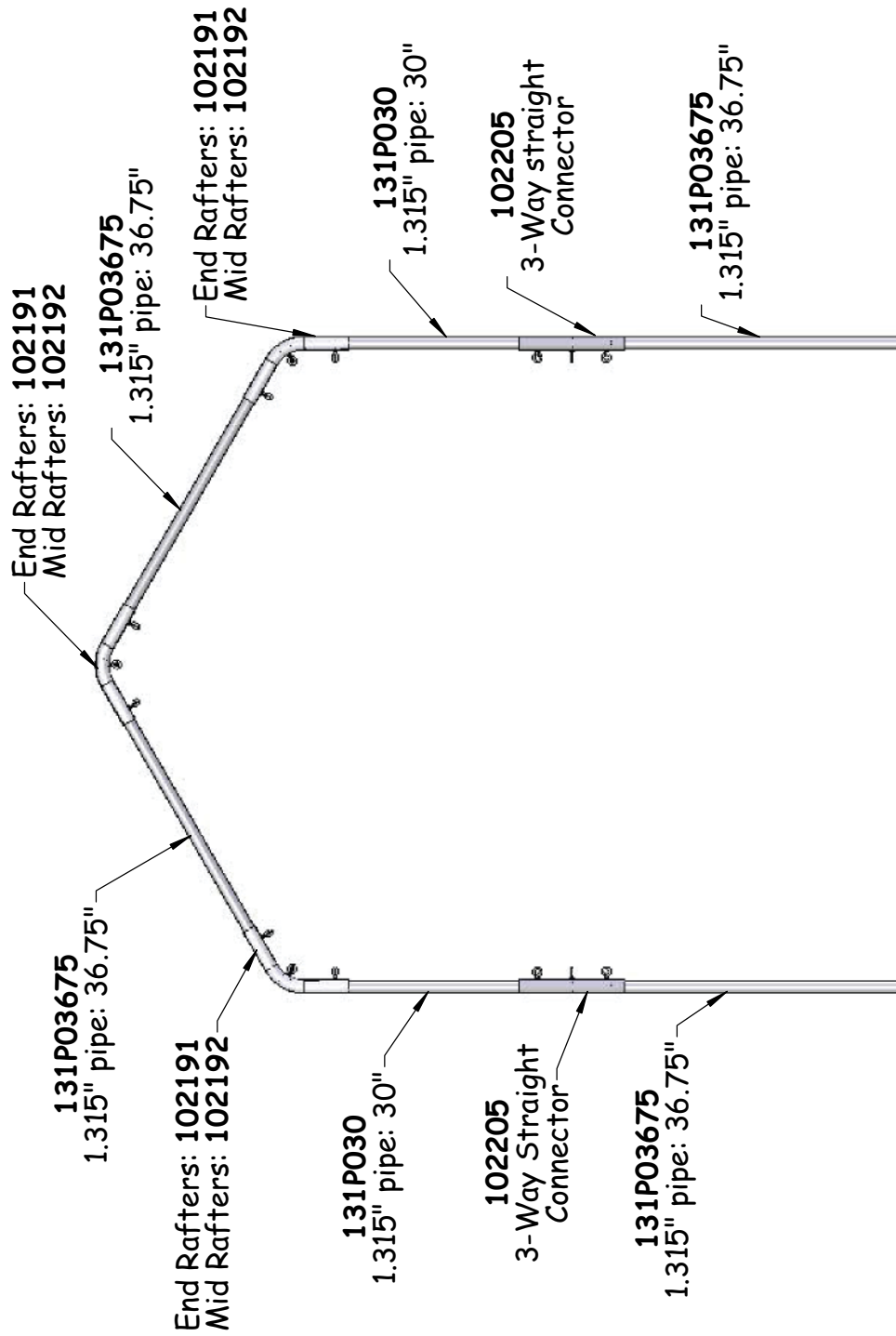

SIDE PROFILE - 104321

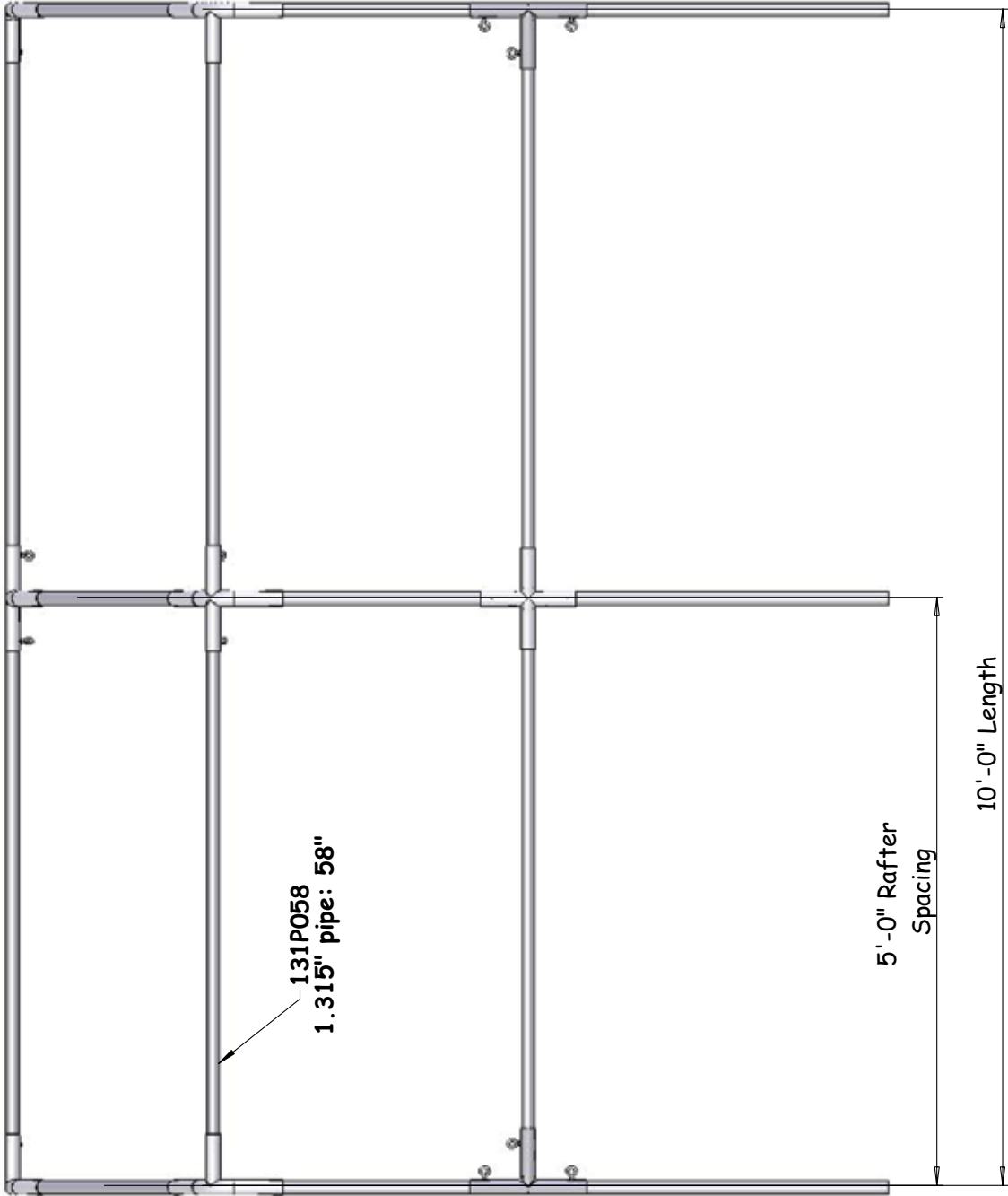

SIDE PROFILE - 104322

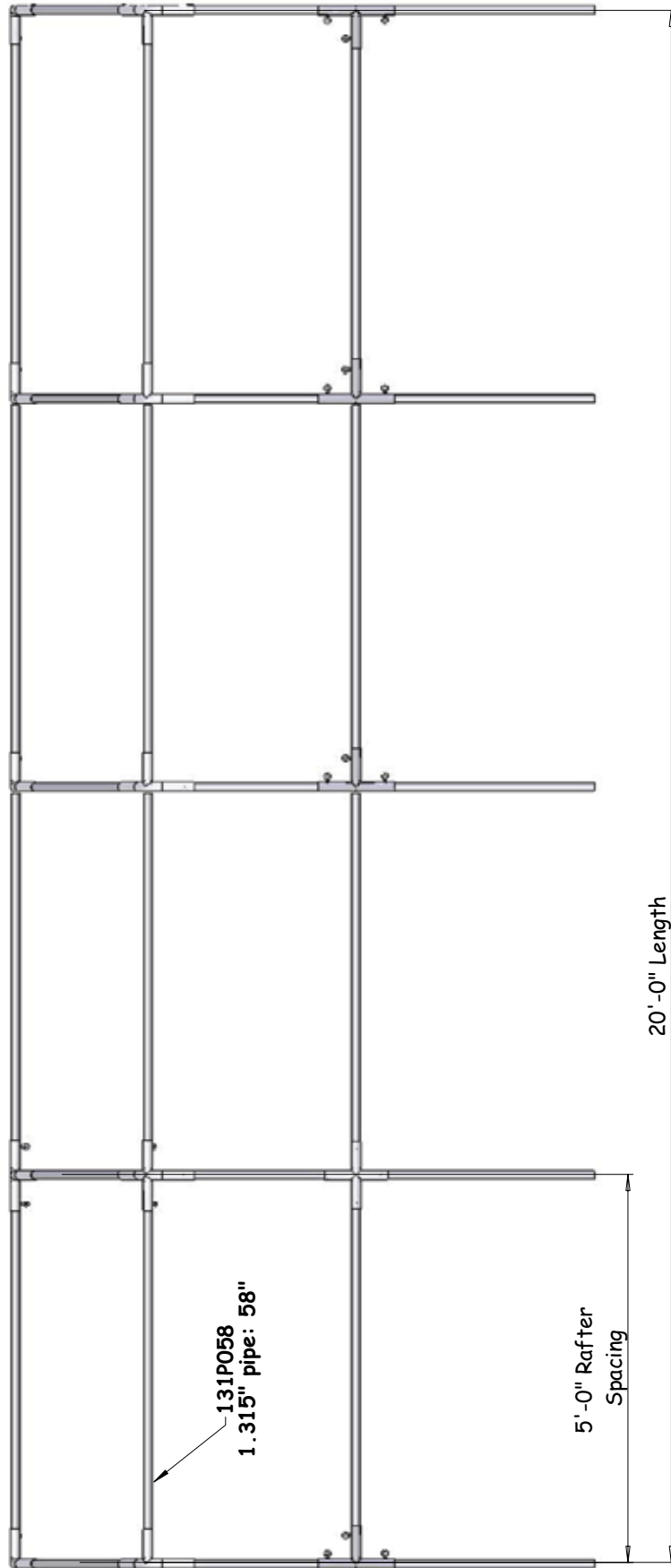

SIDE PROFILE - 104323

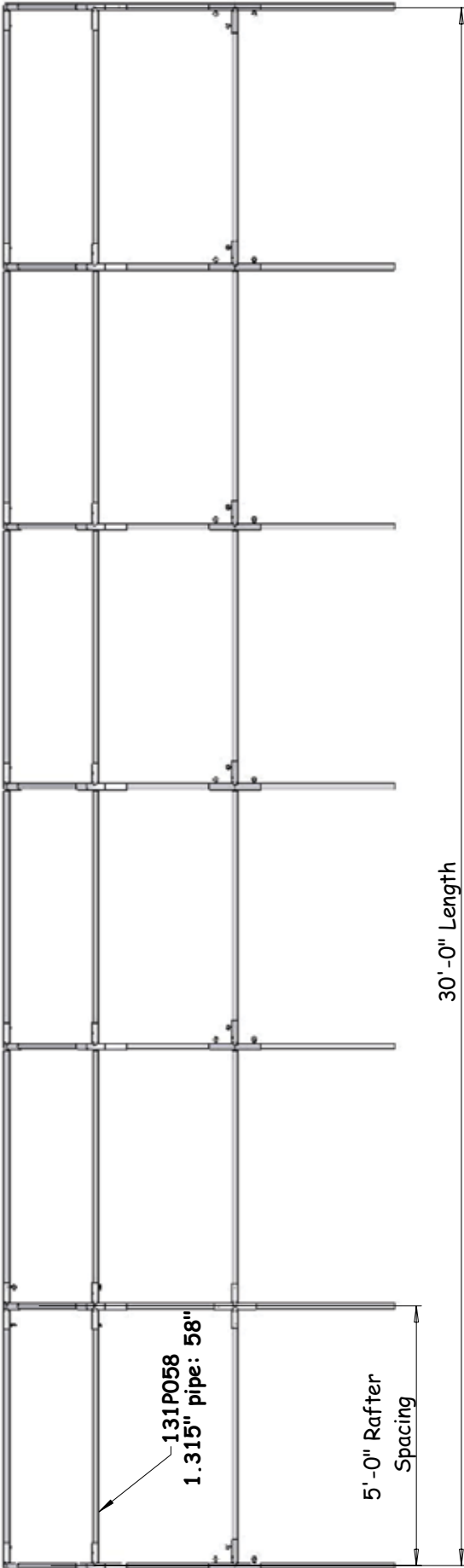

CONNECTIONS

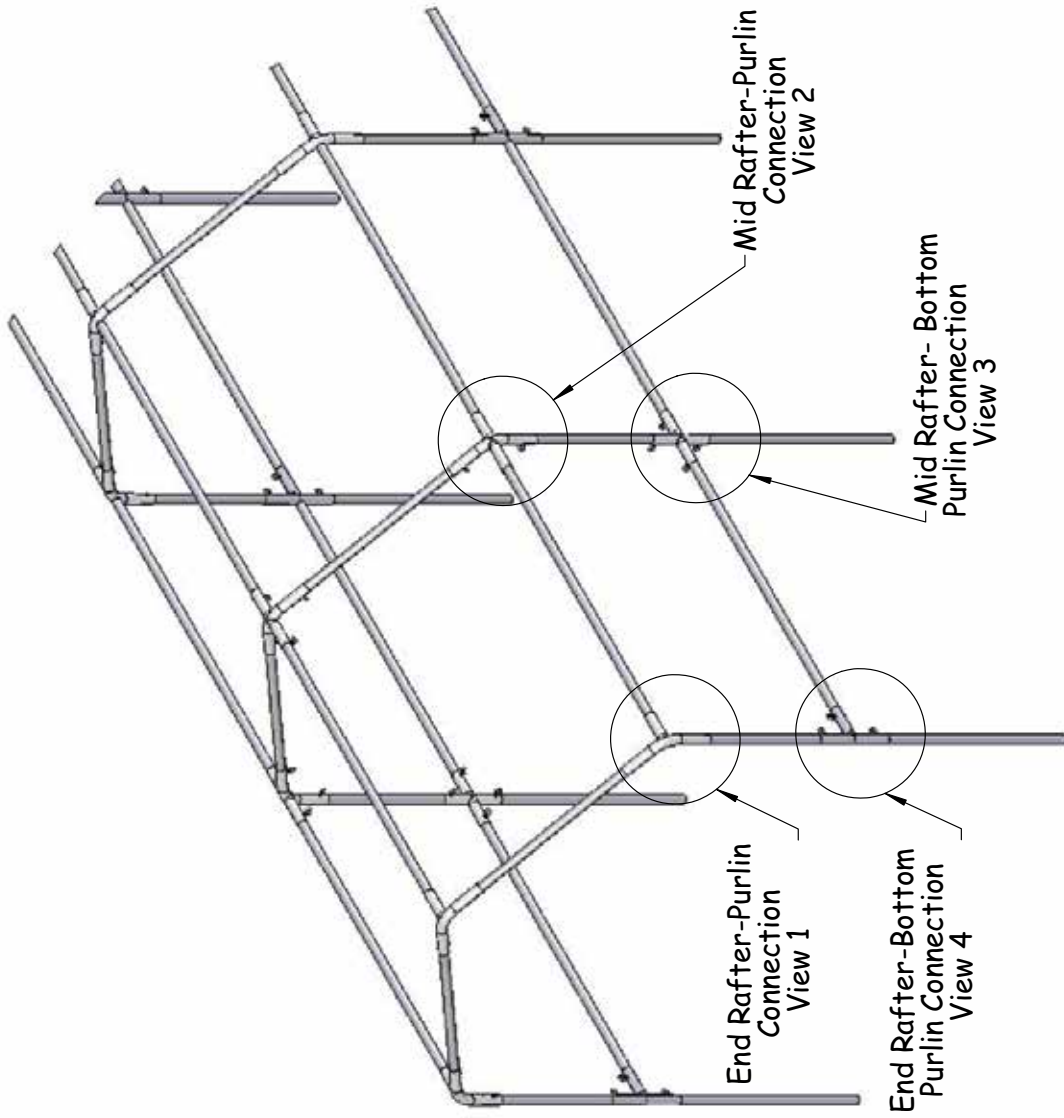

CONNECTION DETAILS

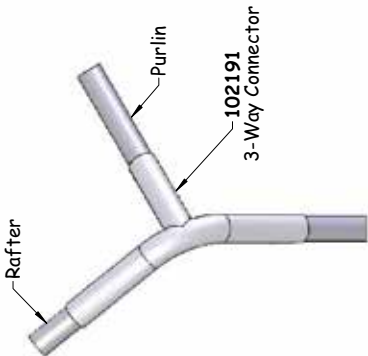

View 1
End Rafter-Purlin
Connection

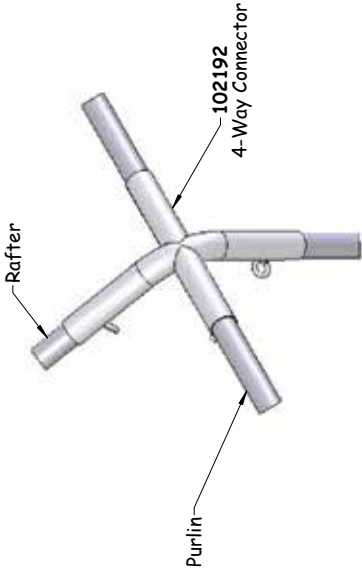

View 2
Mid Rafter-Purlin
Connection

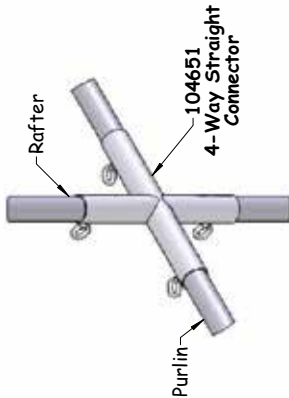

View 3
Mid Rafter-
Bottom Purlin
Connection

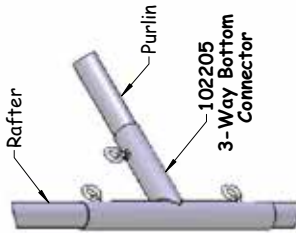

View 4
End Rafter-
Bottom Purlin
Connection